



# ENT INSTRUMENTS

# CONTENTS

## Otology

Micro Ear Forceps	22-1
Micro Ear Scissors	22-4
Wire Closure Forceps	22-5
Crura and Malleus Nippers	22-6
Knives	22-8
Needles, Picks, Hooks	22-9
Dissectors, Elevators, Curettes, Mobilizers	22-11
Foot Plate Hand Instruments	22-12
Needles, Hooklets	22-13
Suction Tubes	22-16
Ear Specula	22-17
Tuning Forks	22-20
Eustachian Catheters, Snares	22-26
Dressing Forceps	22-27
Polypus Forceps, Foreign Body Forceps	22-28
Punches	22-30
Curettes and Spoons	22-31
Loops, Hooks	22-33
Paracentesis Needles	22-35
Elevators, Raspatories, Curettes	22-37
Syringes	22-39

## Rhinology

Specula	23-41
Snares	23-46
Dressing Forceps, Polypus Forceps	23-47
Septum Forceps	23-48
Cutting Forceps	23-49
Septum Scissors	23-50
Sphenoid Punches, Antrum Punch Forceps	23-56
Knives	23-59
Elevators	23-62

Chisels, Gouges, Osteotomes	23-65
Rhinoplastic Instruments	23-71
Files and Rasps	23-74
Hooks and Retractors	23-79
Curettes	23-84
Adenoid Curettes	23-85
Wash Cannulas, Wash Catheters, Probes	23-88
Sinuscopy Forceps	23-89

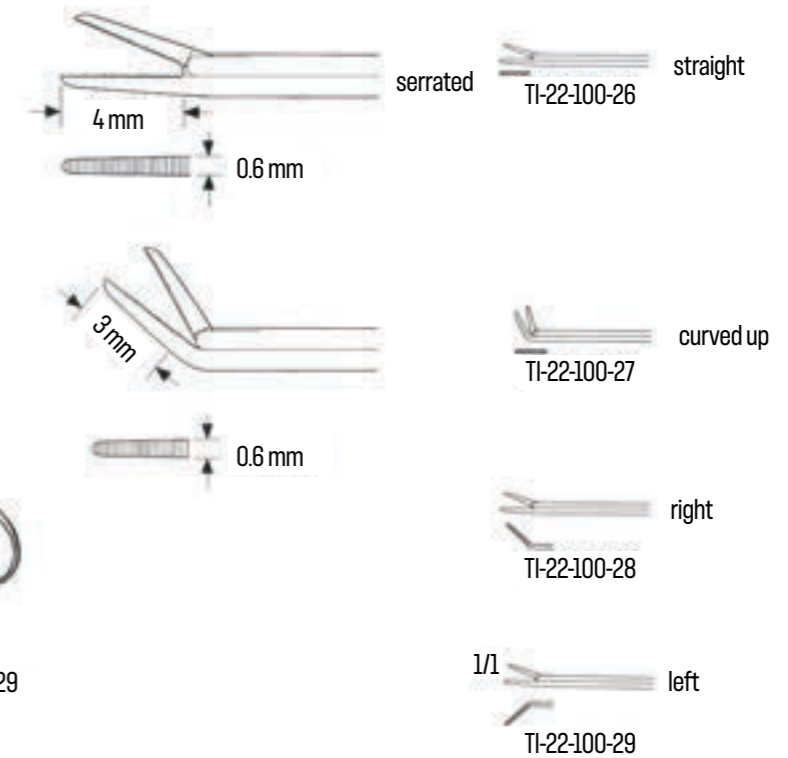
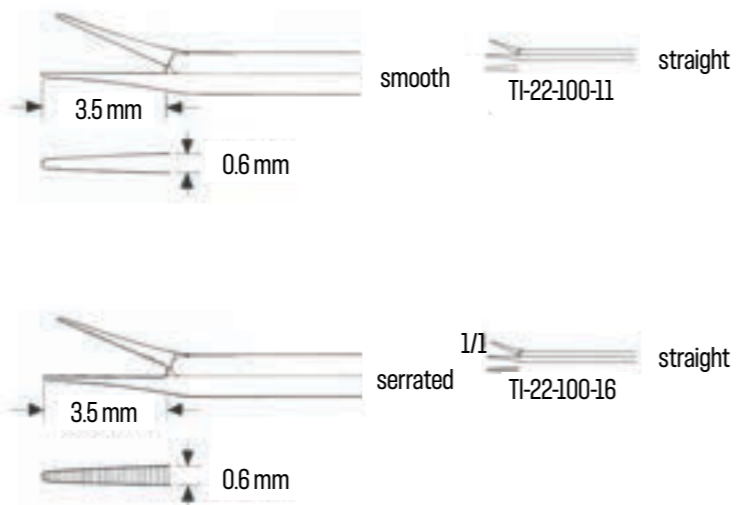
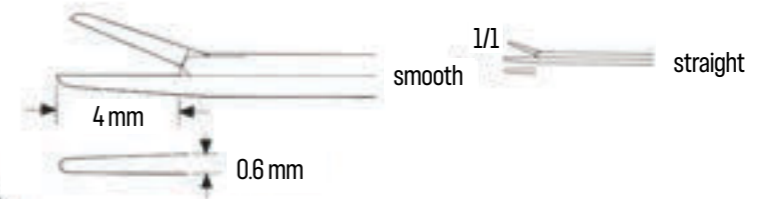
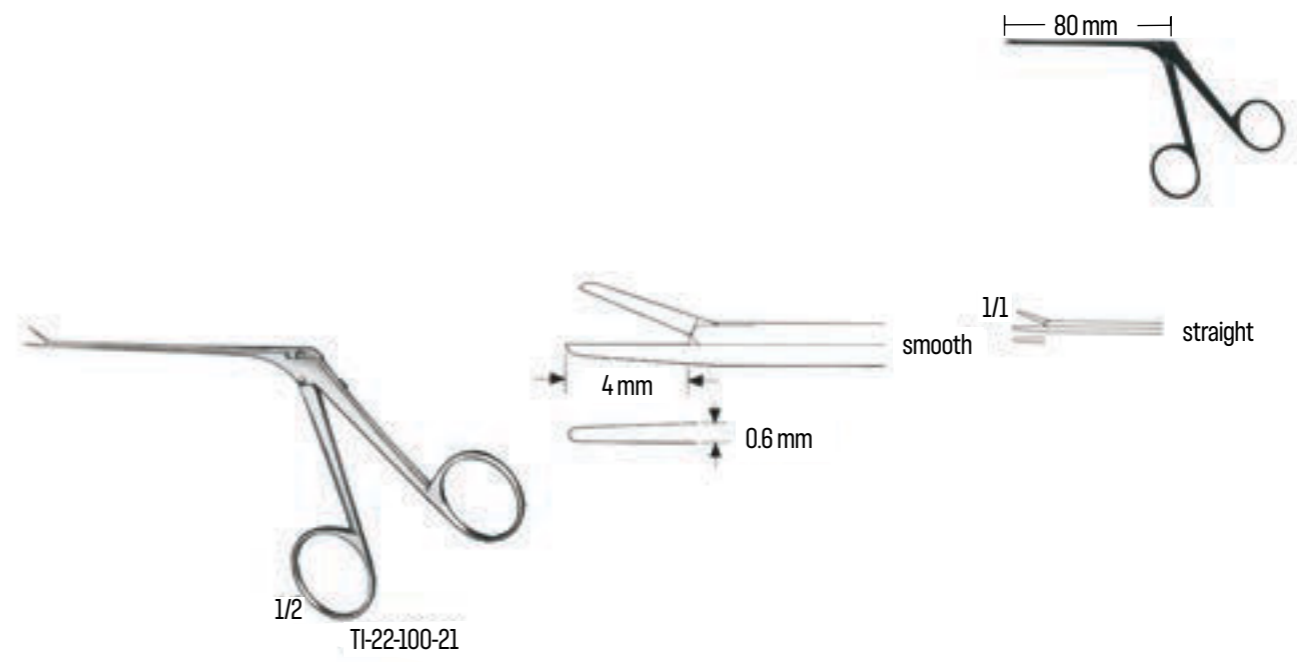
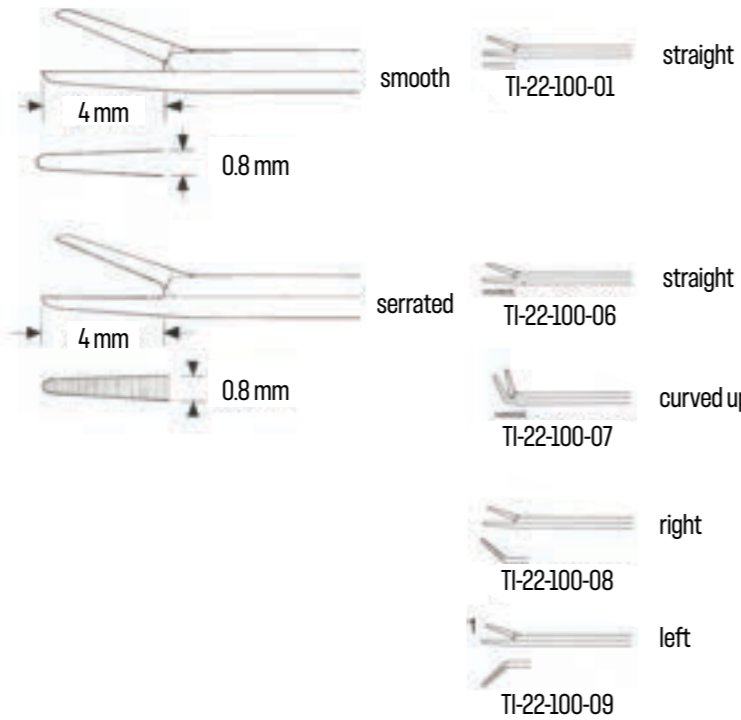
## Oral, Maxillo-Facial Surgery

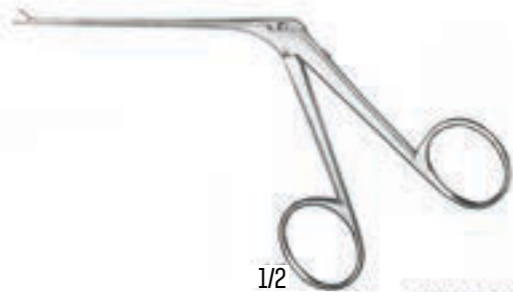
Mouth Gags	24-97
Cheek Lip Retractors	24-102
Tongue Depressors	24-105
Tongue Holding Forceps	24-108
Retractors	24-109
Elevators	24-112
Osteotomes	24-113
Awls	24-114
Disimpaction Forceps	24-115

## Throat Surgery

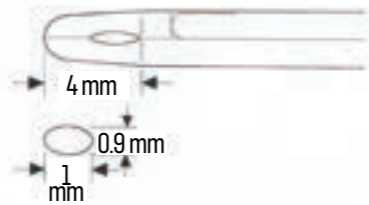
Needles	25-117
Knives, Ligature Carriers	25-118
Retractors, Enucleators, Dissectors	25-121
Tonsil Seizing Forceps	25-122
Tonsil Snares	25-123
Tonsillectomes	25-124
Tonsil Punch Forceps, Tonsil Hemostats	25-125
Broncho-Esophagoscopy Forceps	25-126
Universal Handles and Interchangeable Tubes	25-127
Cutting and Grasping Tips	25-128
Endolaryngeal Micro-Surgery Instruments	25-129
Forceps for Laryngo-Bronchoscopy	25-130
Laryngeal Mirrors	25-131
Laryngeal Polypus Forceps	25-133



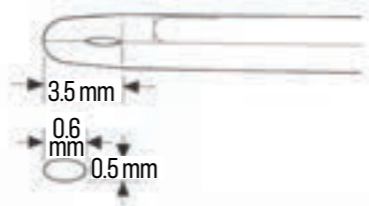




1/2  
 TI-22-102-01 - TI-22-102-04



- straight  
TI-22-102-01
- curved up  
TI-22-102-02
- right  
TI-22-102-03
- left  
TI-22-102-04



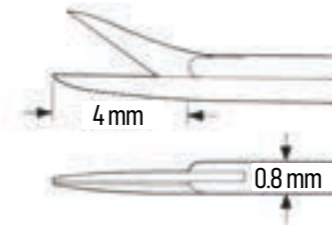
- straight  
TI-22-102-11
- curved up  
TI-22-102-12
- right  
TI-22-102-13
- left  
TI-22-102-14



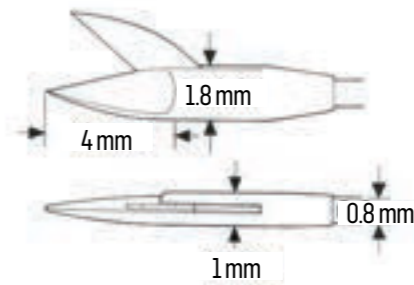
1/2  
 TI-22-102-11 - TI-22-102-14



1/2  
 Bellucci  
 TI-22-104-01 - TI-22-104-04

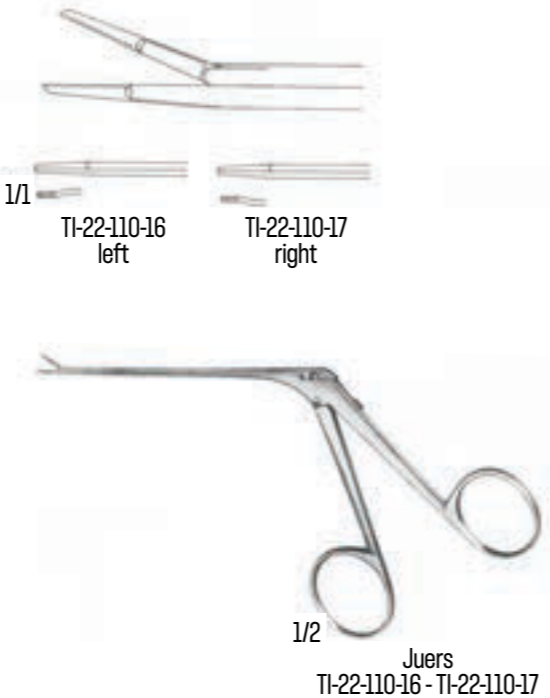
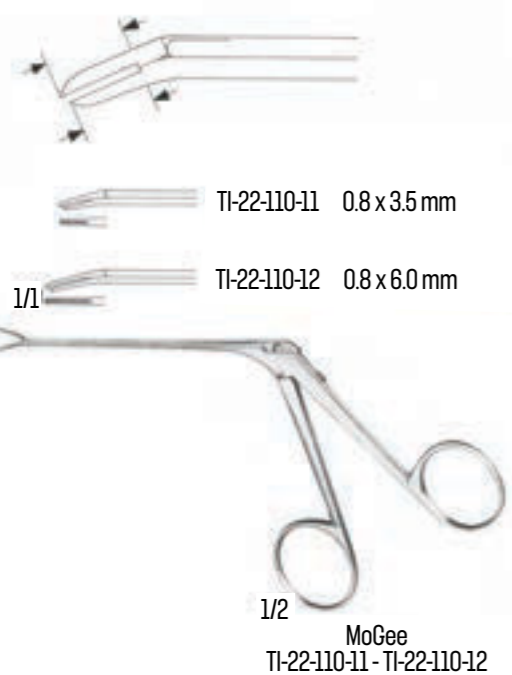
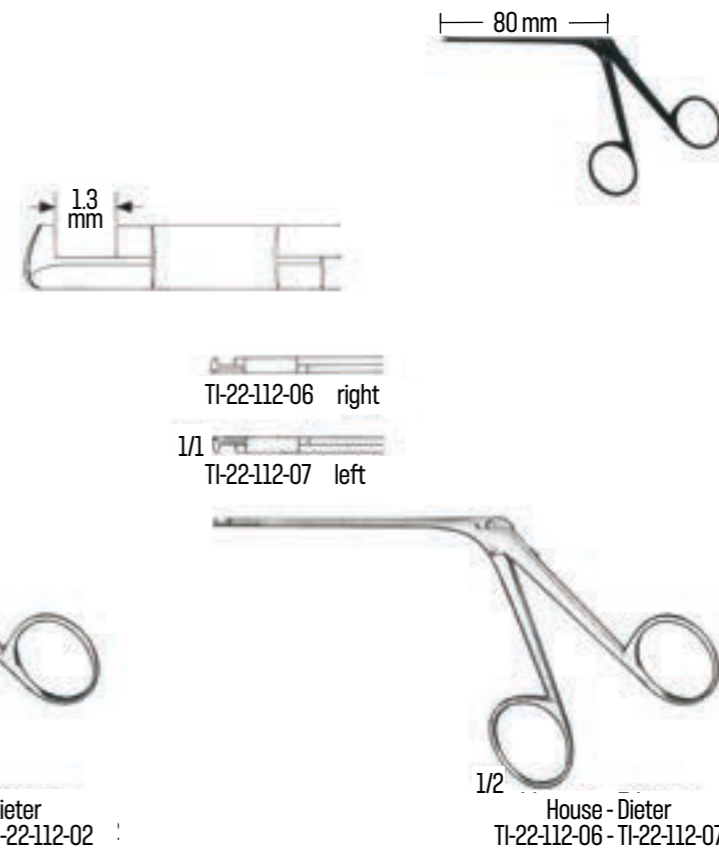
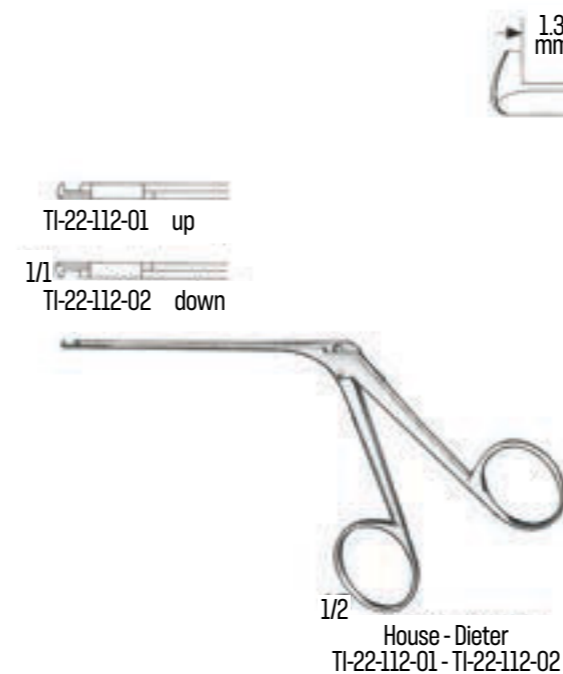
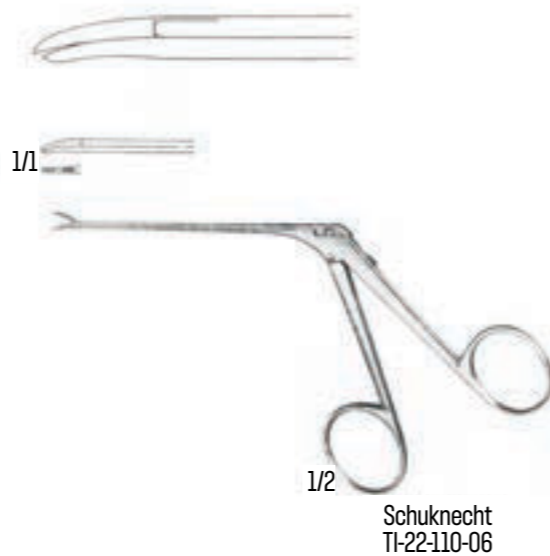


- straight  
TI-22-104-01
- curved up  
TI-22-104-02
- right  
TI-22-104-03
- left  
TI-22-104-04



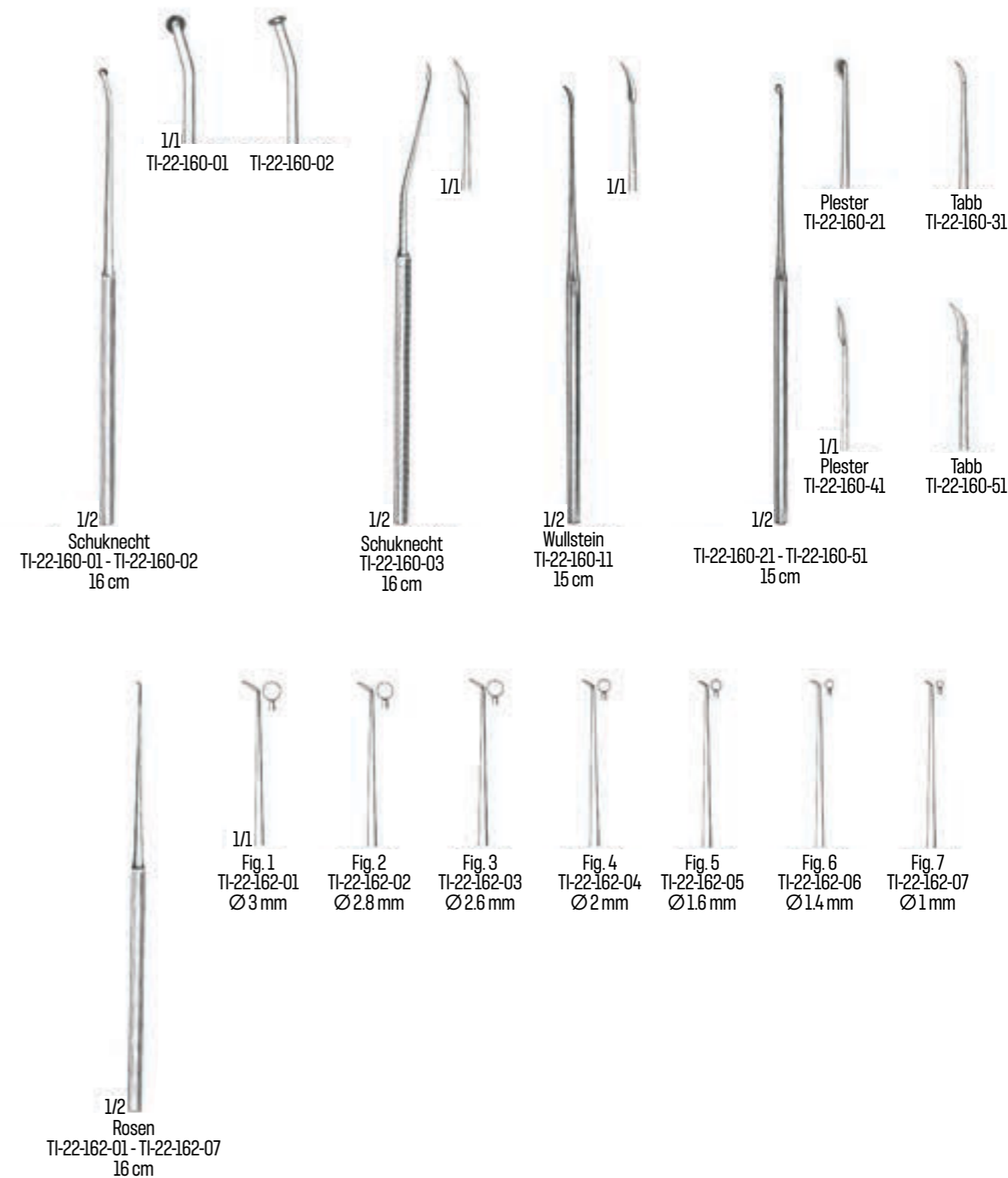
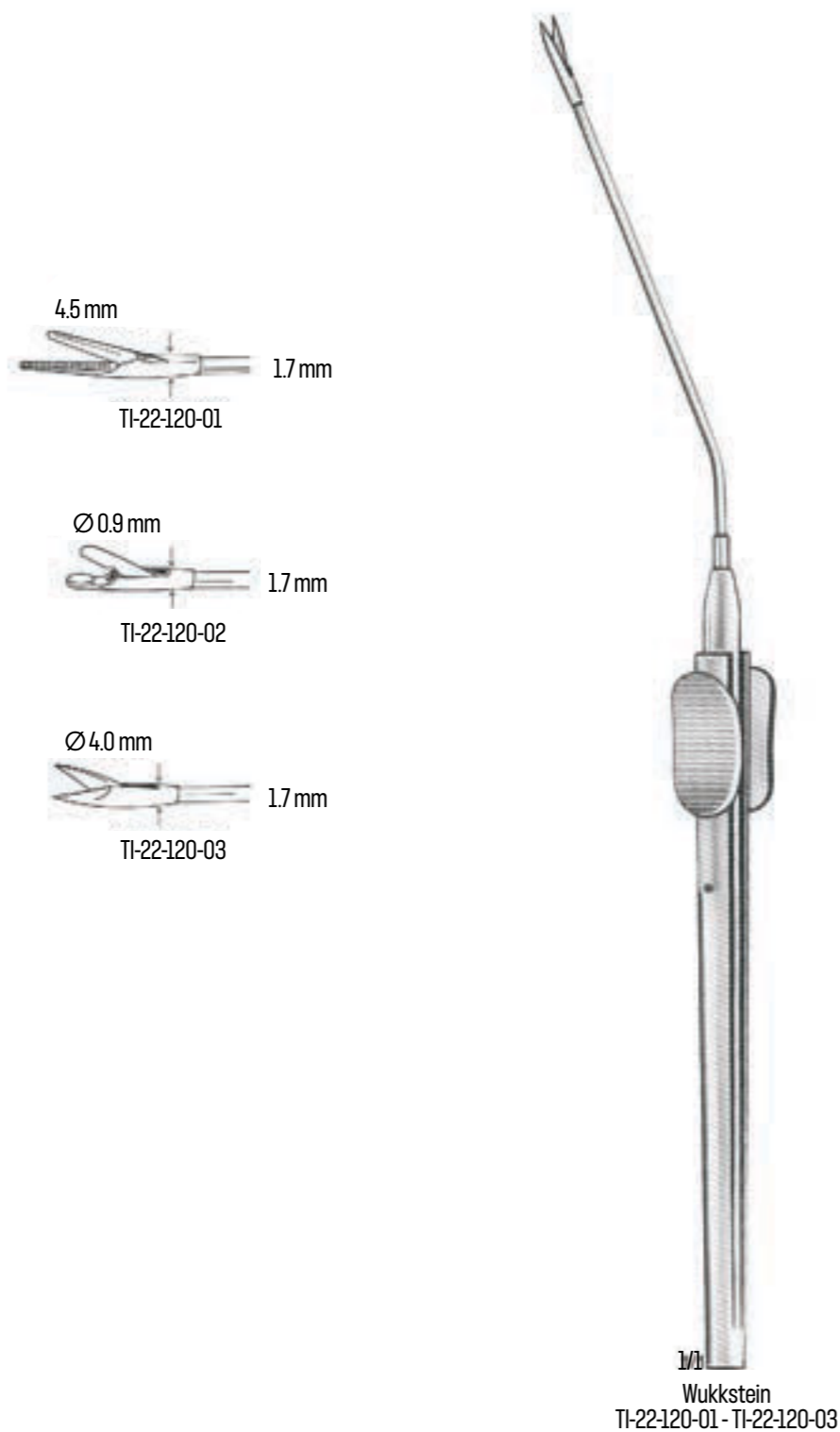
1/2  
 Wullstein  
 TI-22-104-31 - TI-22-104-34

- straight  
TI-22-104-31
- curved up  
TI-22-104-32
- right  
TI-22-104-33
- left  
TI-22-104-34



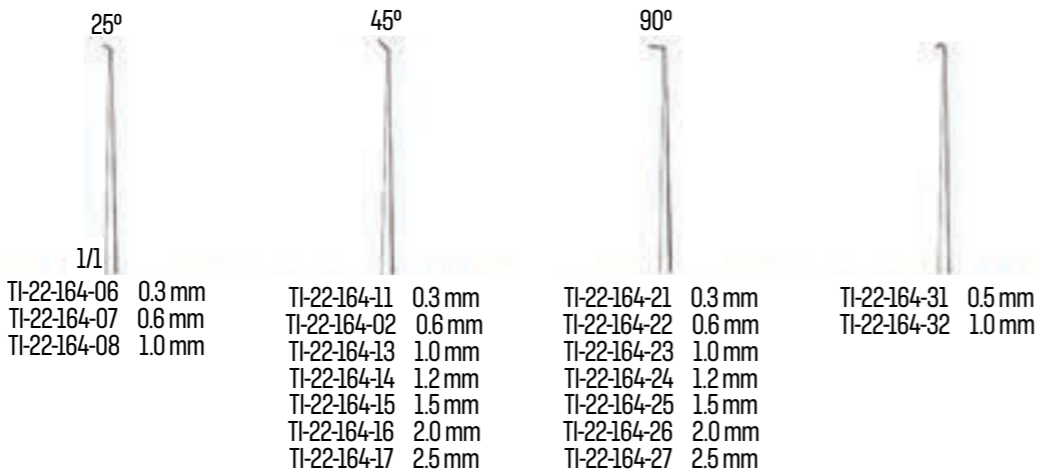
MICRO PINZAS AURICULARES

CUCHILLOS





Barbara TI-22-164-01 16 cm  
 Barbara TI-22-164-02 16 cm  
 Barbara TI-22-164-03 16 cm  
 Rosen TI-22-164-04 16 cm



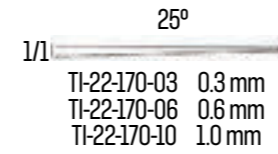
25°  
 1/1  
 TI-22-164-06 0.3 mm  
 TI-22-164-07 0.6 mm  
 TI-22-164-08 1.0 mm

45°  
 TI-22-164-11 0.3 mm  
 TI-22-164-02 0.6 mm  
 TI-22-164-13 1.0 mm  
 TI-22-164-14 1.2 mm  
 TI-22-164-15 1.5 mm  
 TI-22-164-16 2.0 mm  
 TI-22-164-17 2.5 mm

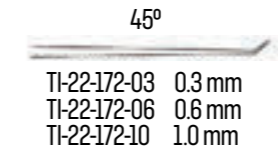
90°  
 TI-22-164-21 0.3 mm  
 TI-22-164-22 0.6 mm  
 TI-22-164-23 1.0 mm  
 TI-22-164-24 1.2 mm  
 TI-22-164-25 1.5 mm  
 TI-22-164-26 2.0 mm  
 TI-22-164-27 2.5 mm

TI-22-164-31 0.5 mm  
 TI-22-164-32 1.0 mm

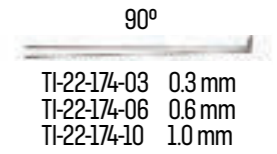
1/2  
 TI-22-164-01 - TI-22-164-32  
 16 cm



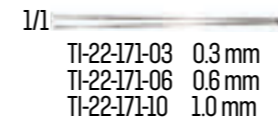
25°  
 1/1  
 TI-22-170-03 0.3 mm  
 TI-22-170-06 0.6 mm  
 TI-22-170-10 1.0 mm



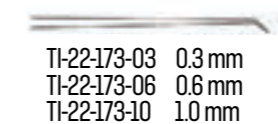
45°  
 TI-22-172-03 0.3 mm  
 TI-22-172-06 0.6 mm  
 TI-22-172-10 1.0 mm



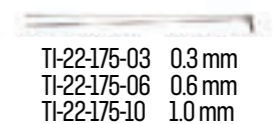
90°  
 TI-22-174-03 0.3 mm  
 TI-22-174-06 0.6 mm  
 TI-22-174-10 1.0 mm



1/1  
 TI-22-171-03 0.3 mm  
 TI-22-171-06 0.6 mm  
 TI-22-171-10 1.0 mm



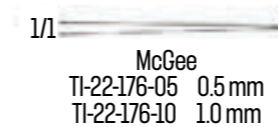
TI-22-173-03 0.3 mm  
 TI-22-173-06 0.6 mm  
 TI-22-173-10 1.0 mm



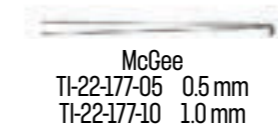
TI-22-175-03 0.3 mm  
 TI-22-175-06 0.6 mm  
 TI-22-175-10 1.0 mm



1/2  
 TI-22-170-03 - TI-22-178-01



1/1  
 McGee  
 TI-22-176-05 0.5 mm  
 TI-22-176-10 1.0 mm



McGee  
 TI-22-177-05 0.5 mm  
 TI-22-177-10 1.0 mm

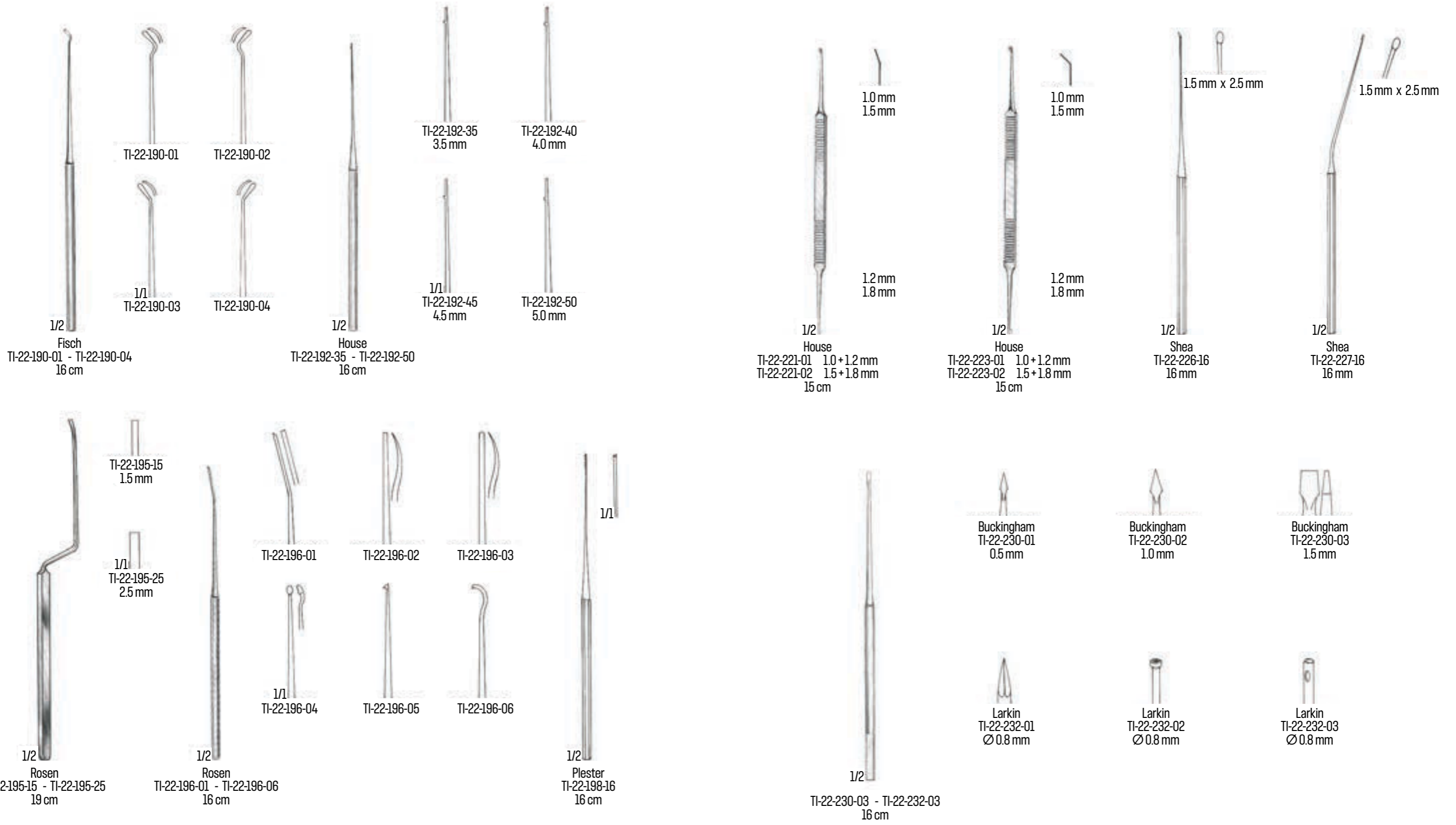


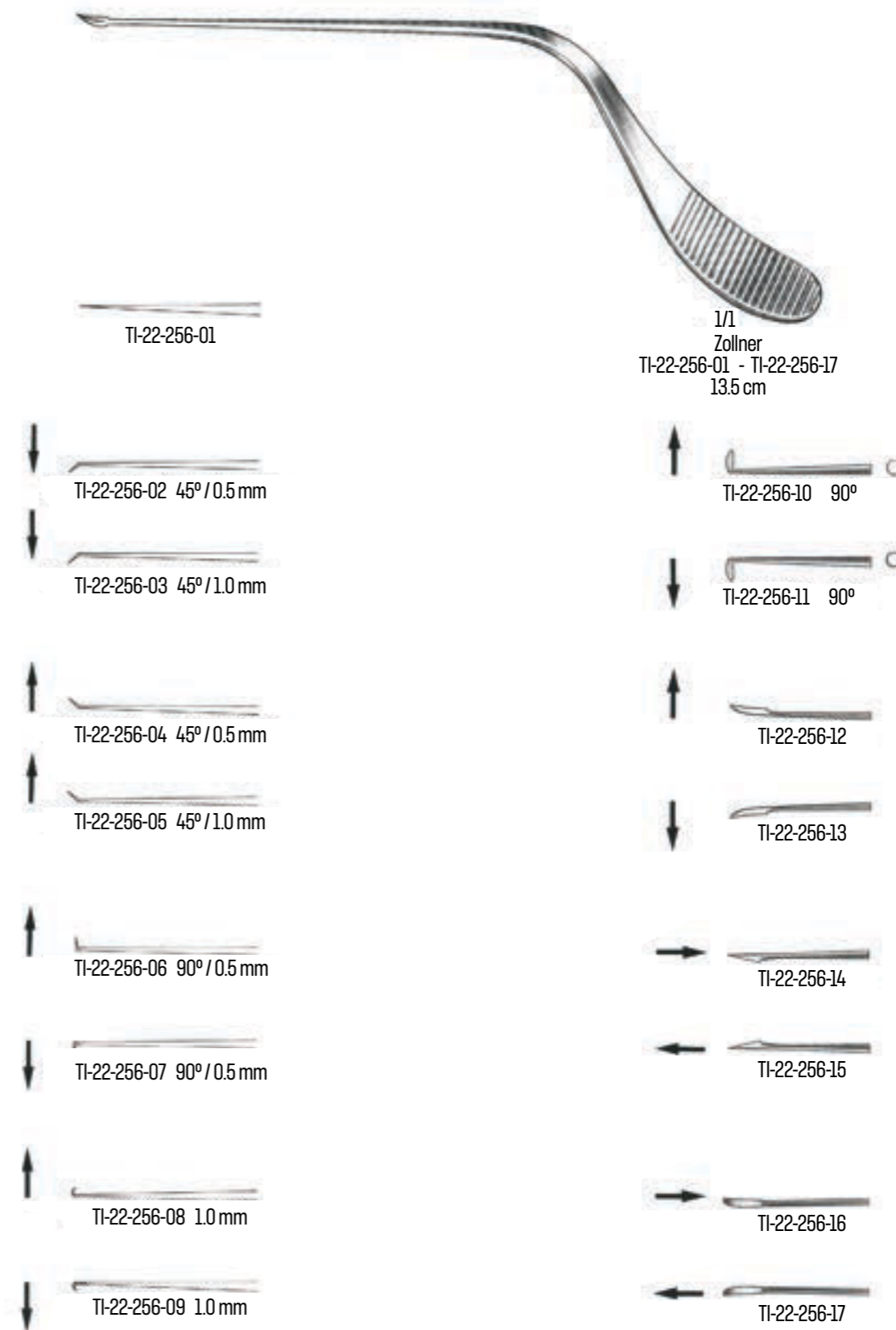
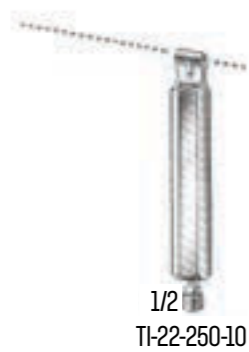
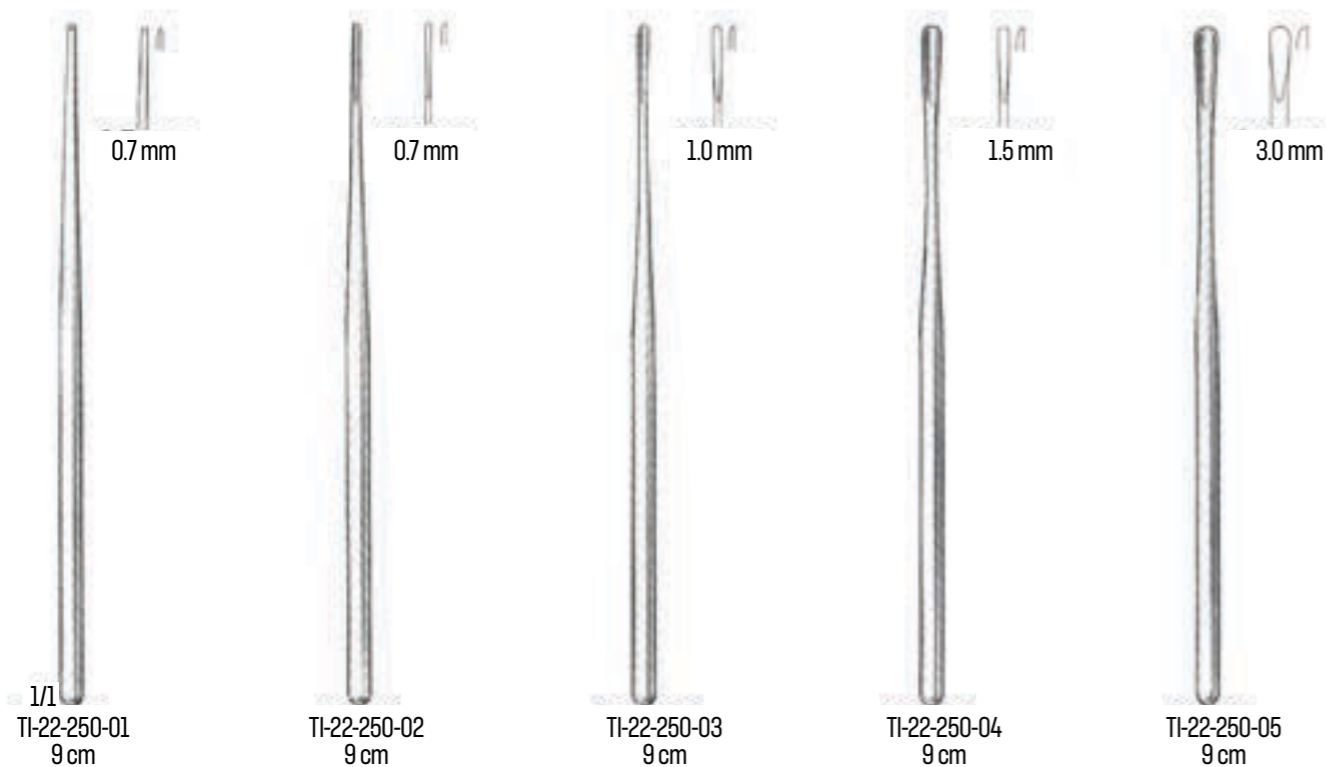
Barbara  
 TI-22-178-00



Rosen  
 TI-22-178-01







1/1  
Schuknecht  
TI-22-260-01 - TI-22-264-40  
16.5 cm

		TI-22-260-01				
		TI-22-260-02				
			↓	↑	→	←
45°	0.2 mm	TI-22-262-02	TI-22-262-12	TI-22-262-22	TI-22-262-32	
	0.4 mm	TI-22-262-04	TI-22-262-14	TI-22-262-24	TI-22-262-34	
	0.6 mm	TI-22-262-06	TI-22-262-16	TI-22-262-26	TI-22-262-36	
	0.8 mm	TI-22-262-08	TI-22-262-18	TI-22-262-28	TI-22-262-38	
	1.0 mm	TI-22-262-10	TI-22-262-20	TI-22-262-30	TI-22-262-40	
			↓	↑	→	←
90°	0.2 mm	TI-22-264-02	TI-22-264-12	TI-22-264-22	TI-22-264-32	
	0.4 mm	TI-22-264-04	TI-22-264-14	TI-22-264-24	TI-22-264-34	
	0.6 mm	TI-22-264-06	TI-22-264-16	TI-22-264-26	TI-22-264-36	
	0.8 mm	TI-22-264-08	TI-22-264-18	TI-22-264-28	TI-22-264-38	
	1.0 mm	TI-22-264-10	TI-22-264-20	TI-22-264-30	TI-22-264-40	



House

TI-22-300-09	0.9+0.7 mm
TI-22-300-12	1.2+0.9 mm
TI-22-300-15	1.5+1.2 mm
TI-22-300-18	1.8+1.8 mm
TI-22-300-25	2.5+2.0 mm
TI-22-300-30	3.0+2.0 mm
TI-22-300-45	4.5+2.0 mm



Baron (Schuknecht)

TI-22-302-10	0.0+75 mm
TI-22-302-15	1.5+75 mm
TI-22-302-20	2.0+75 mm



Zollner  
TI-22-305-00



TI-22-305-05 Ø 0.5 mm  
TI-22-305-07 Ø 0.7 mm



Wullstein  
TI-22-306-00



Wullstein  
TI-22-307-00



House

TI-22-308-06	0.6 mm
TI-22-308-08	0.8 mm
TI-22-308-10	1.0 mm
TI-22-308-12	1.2 mm
TI-22-308-15	1.5 mm
TI-22-308-18	1.8 mm
TI-22-308-20	2.0 mm
TI-22-308-22	2.2 mm
TI-22-308-25	2.5 mm
TI-22-308-30	3.0 mm

Ø - inside diameter



Set 1-3  
 TI-22-400-03

- mm
- 2.0
- 3.0
- 3.5
- 4.0
- 5.0
- 6.5
- 7.5

- Politzer
- TI-22-401-01
- TI-22-401-02
- TI-22-401-03
- TI-22-401-04



for children  
 Set 0-2  
 TI-22-404-03

- Hartmann
- TI-22-405-00
- TI-22-405-01
- TI-22-405-02



for adults  
 Set 2-4  
 TI-22-408-03  
 Set 1-4  
 TI-22-408-04

- Hartmann
- TI-22-409-01
- TI-22-409-02
- TI-22-409-03
- TI-22-409-04

Aluminium black



Zollner  
 TI-22-420-00  
 Set 1-6

- TI-22-421-01  
5.5 x 6.5 mm
- TI-22-421-02  
6.5 x 7.5 mm
- TI-22-421-03  
7.5 x 8.5 mm
- TI-22-421-04  
8.5 x 9.5 mm
- TI-22-421-05  
9.5 x 10.5 mm
- TI-22-421-06  
10.5 x 11.5 mm



Boucheron  
 TI-22-424-00  
 Set 1-4

- TI-22-425-01  
3.5 mm
- TI-22-425-02  
4.5 mm
- TI-22-425-03  
5.5 mm
- TI-22-425-04  
6.5 mm



Farrior  
 TI-22-430-33 - TI-22-435-75

- |                    |                |              |              |              |
|--------------------|----------------|--------------|--------------|--------------|
| ○ 3.3 mm 22-430-33 | ○ 3.0 x 4.0 mm | TI-22-432-30 | TI-22-433-30 | TI-22-435-30 |
| ○ 4.3 mm 22-430-43 | ○ 4.0 x 5.0 mm | TI-22-432-40 | TI-22-433-40 | TI-22-435-40 |
| ○ 4.8 mm 22-430-48 | ○ 4.5 x 5.5 mm | TI-22-432-45 | TI-22-433-45 | TI-22-435-45 |
| ○ 5.3 mm 22-430-53 | ○ 5.0 x 6.0 mm | TI-22-432-50 | TI-22-433-50 | TI-22-435-50 |
| ○ 5.8 mm 22-430-58 | ○ 5.5 x 6.5 mm | TI-22-432-55 | TI-22-433-55 | TI-22-435-55 |
| ○ 6.3 mm 22-430-63 | ○ 6.0 x 7.0 mm | TI-22-432-60 | TI-22-433-60 | TI-22-435-60 |
| ○ 6.7 mm 22-430-67 | ○ 6.5 x 7.5 mm | TI-22-432-65 | TI-22-433-65 | TI-22-435-65 |
| ○ 7.2 mm 22-430-72 | ○ 7.0 x 8.0 mm | TI-22-432-70 | TI-22-433-70 | TI-22-435-70 |
| ○ 7.7 mm 22-430-77 | ○ 7.5 x 8.5 mm | TI-22-432-75 | TI-22-433-75 | TI-22-435-75 |



black  
 Set 0-3  
 TI-22-410-03

- mm
- 3.0
- 4.0
- 4.5
- 5.0
- 5.5
- 6.5
- 7.0

- Hartmann
- TI-22-411-00
- TI-22-411-01
- TI-22-411-02
- TI-22-411-03



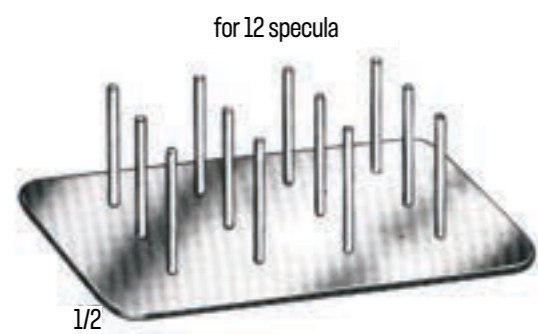
Set 2-4  
 TI-22-414-03  
 Set 1-4  
 TI-22-414-04

- Toynbee
- TI-22-415-01
- TI-22-415-02
- TI-22-415-03
- TI-22-415-04



Set 1-4  
 TI-22-418-04

- Gruber
- TI-22-419-01
- TI-22-419-02
- TI-22-419-03
- TI-22-419-04



for 12 specula

1/2

TI-22-450-12



1/2

Richnau Holmgren

- TI-22-456-02    Ø 2 mm
- TI-22-456-04    Ø 4 mm
- TI-22-456-06    Ø 6 mm



C<sub>2</sub> 16

1/2  
 French  
 TI-22-480-01

C<sub>1</sub> 32

1/2  
 French  
 TI-22-480-02

C 64

1/2  
 Hartmann  
 TI-22-484-01

C 128

1/2  
 Hartmann  
 TI-22-484-02

C' 256

1/2  
 Hartmann  
 TI-22-484-03







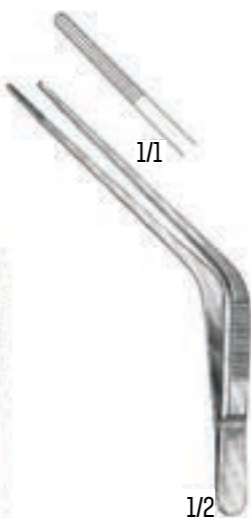
Fig. 1 TI-22-550-01  
Fig. 2 TI-22-550-02  
Fig. 3 TI-22-550-03







Troeltsch (Wilde)  
 TI-22-601-11  
 11 cm



Troeltsch (Wilde)  
 TI-22-603-12  
 12 cm



Troeltsch (Wilde)  
 TI-22-605-13  
 13 cm



Lucae  
 TI-22-607-14  
 14 cm



Jansen  
 TI-22-609-16 16 cm  
 TI-22-609-20 20 cm



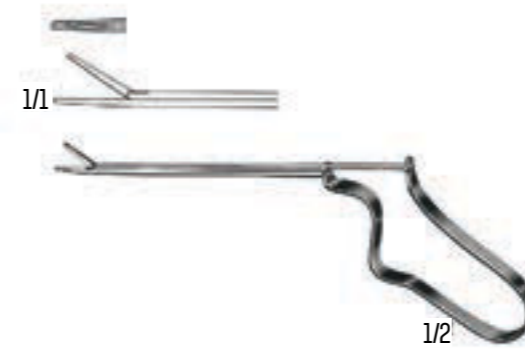
Littauer  
 TI-22-621-12  
 12 cm



Hartmann  
 TI-22-625-12  
 12 cm  
 fine pattern



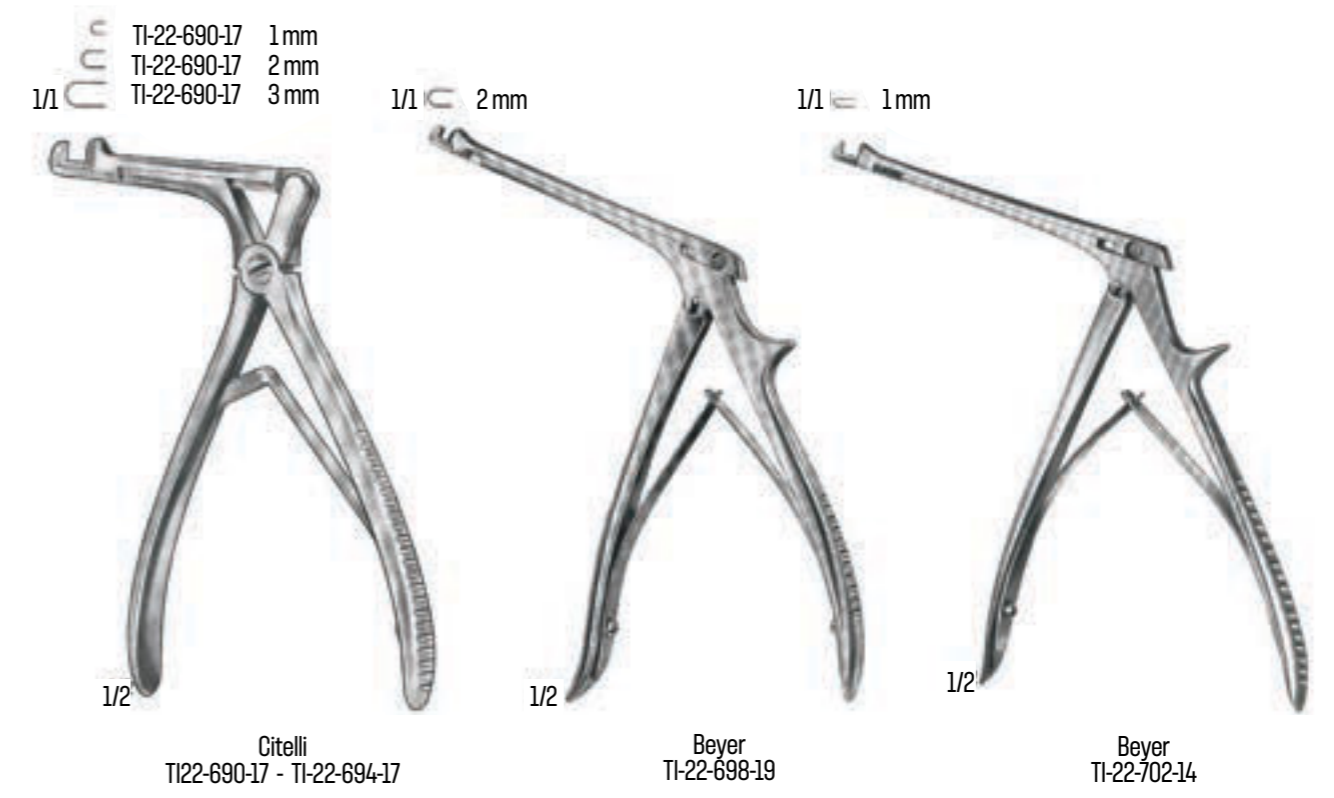
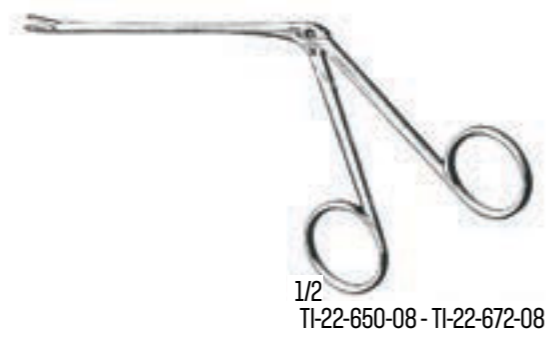
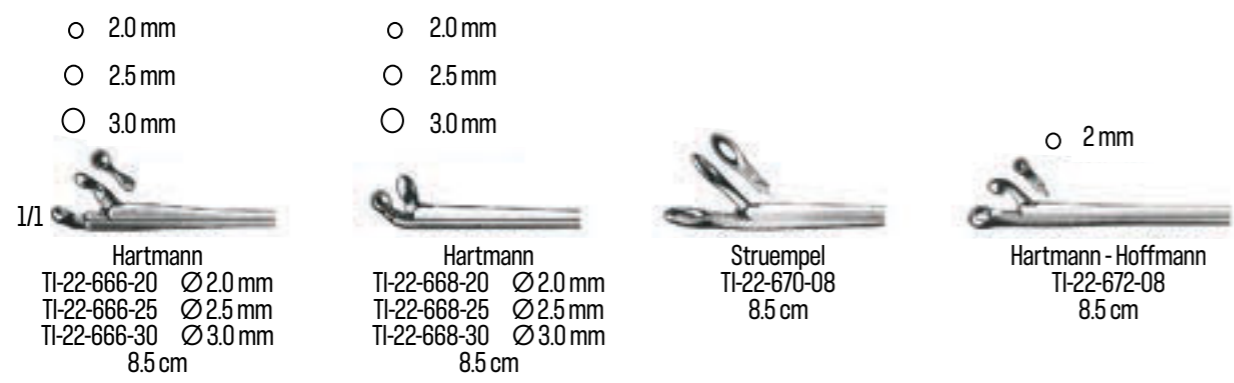
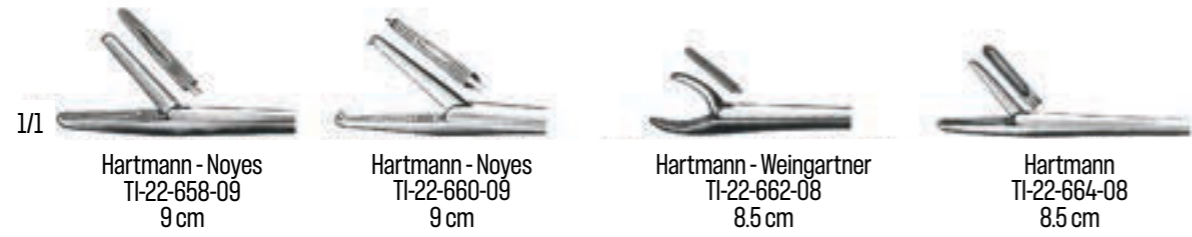
Hartmann  
 TI-22-627-14  
 14 cm  
 standard pattern

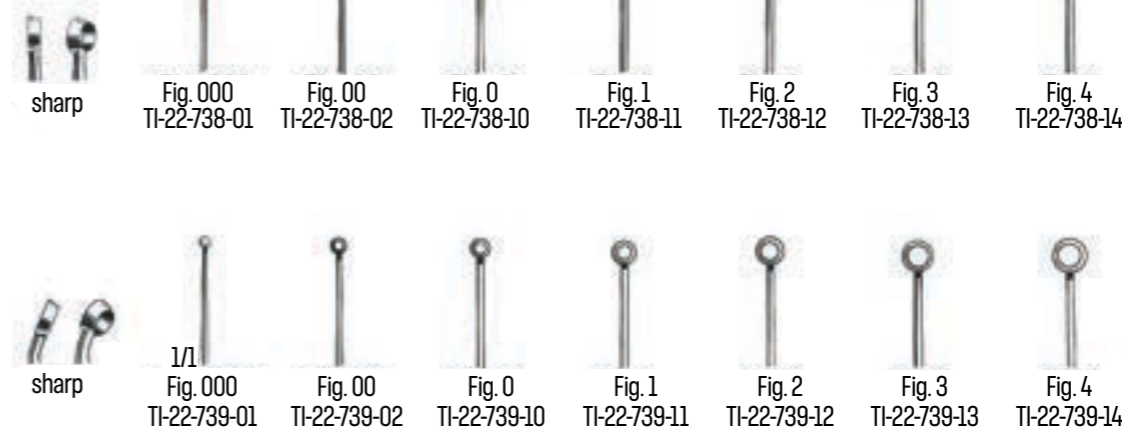
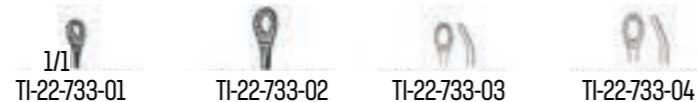


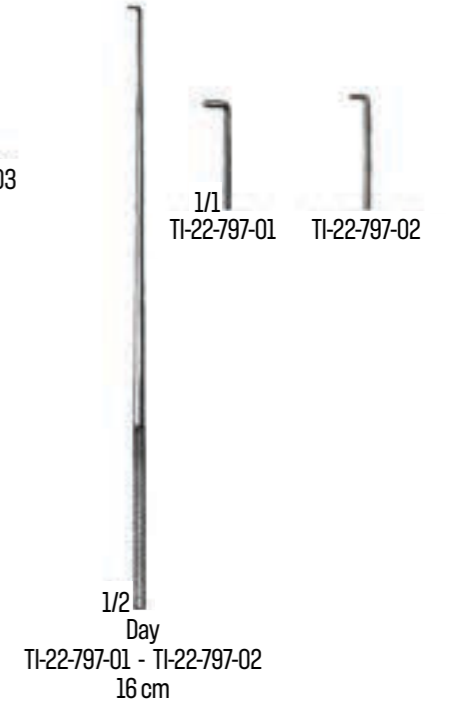
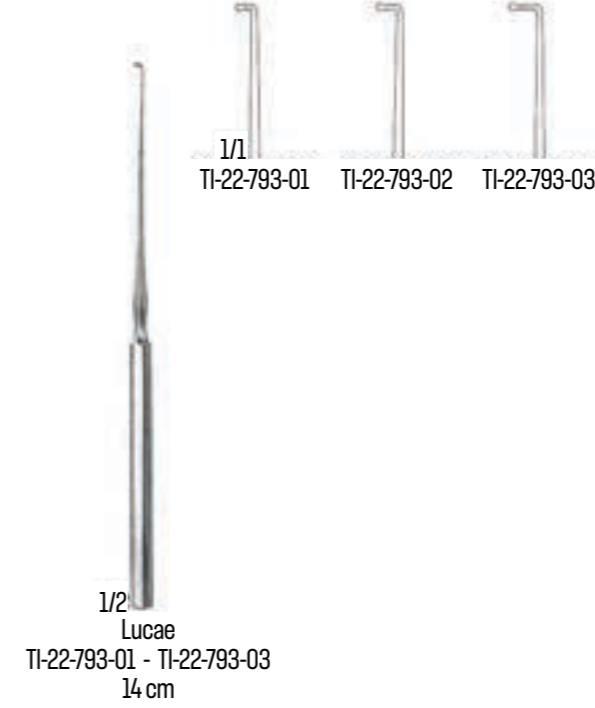
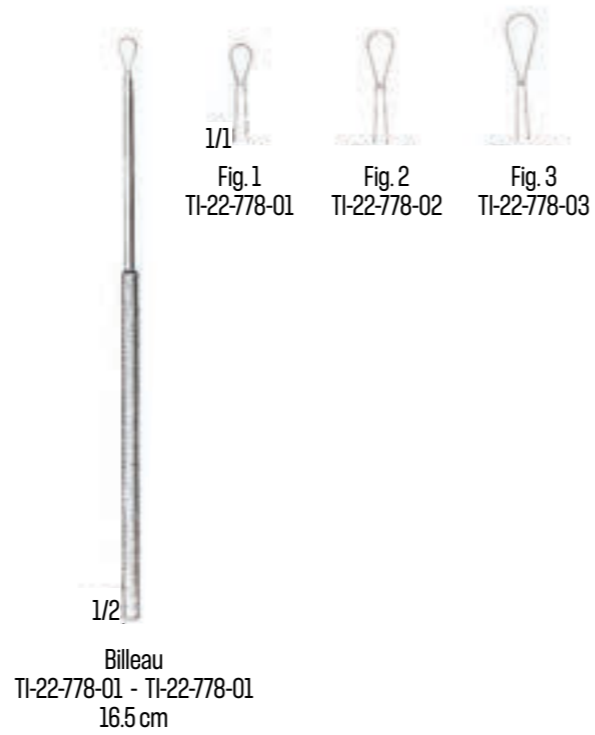
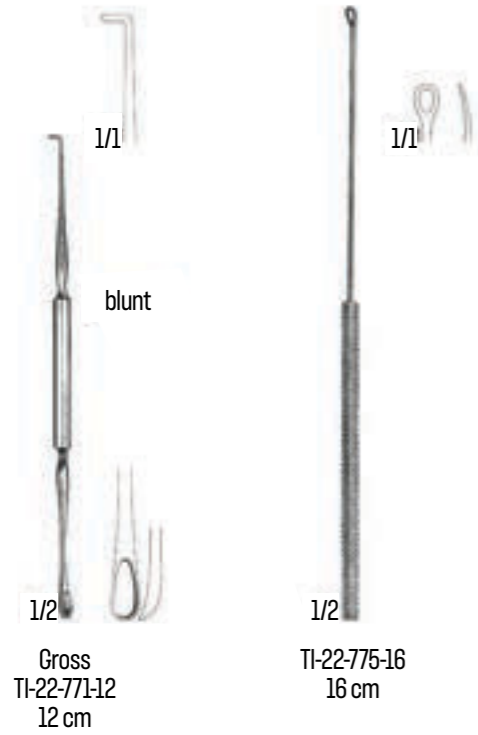
Buck  
 TI-22-632-11  
 11.5 cm

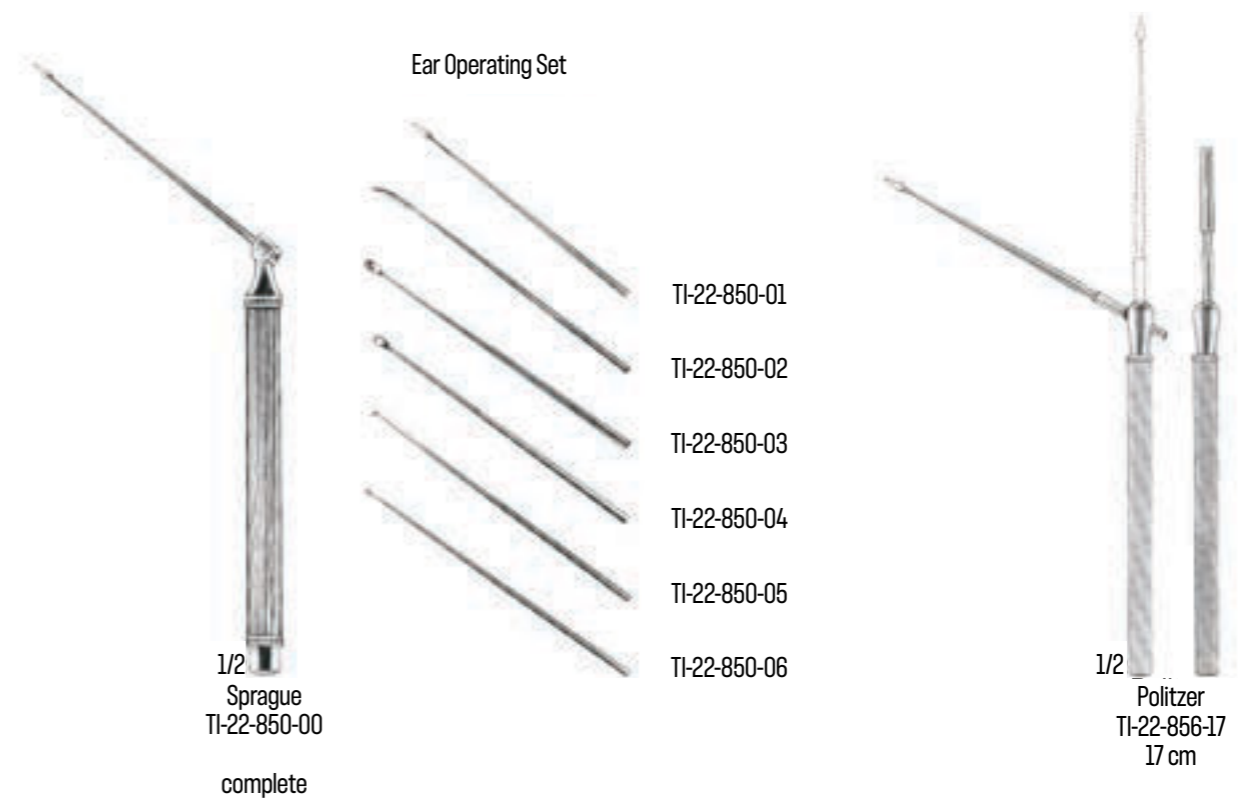
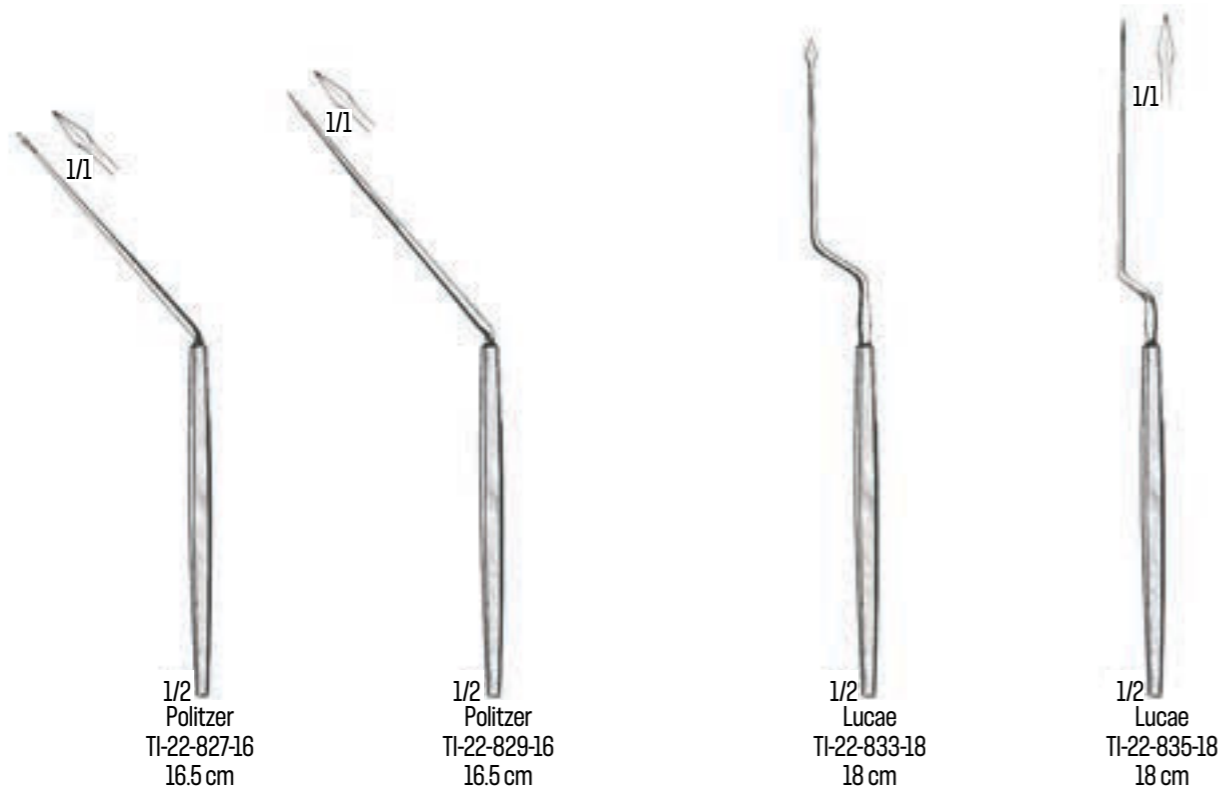
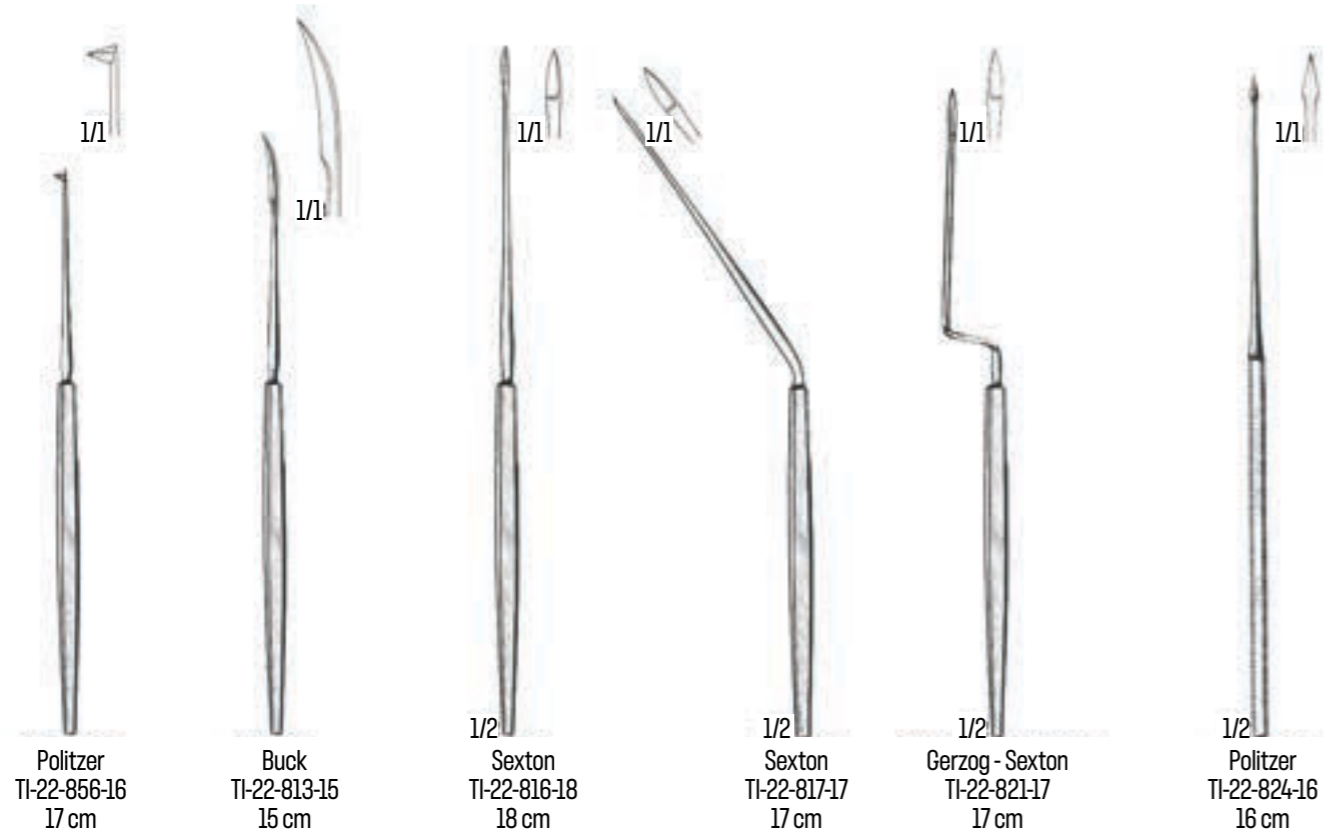


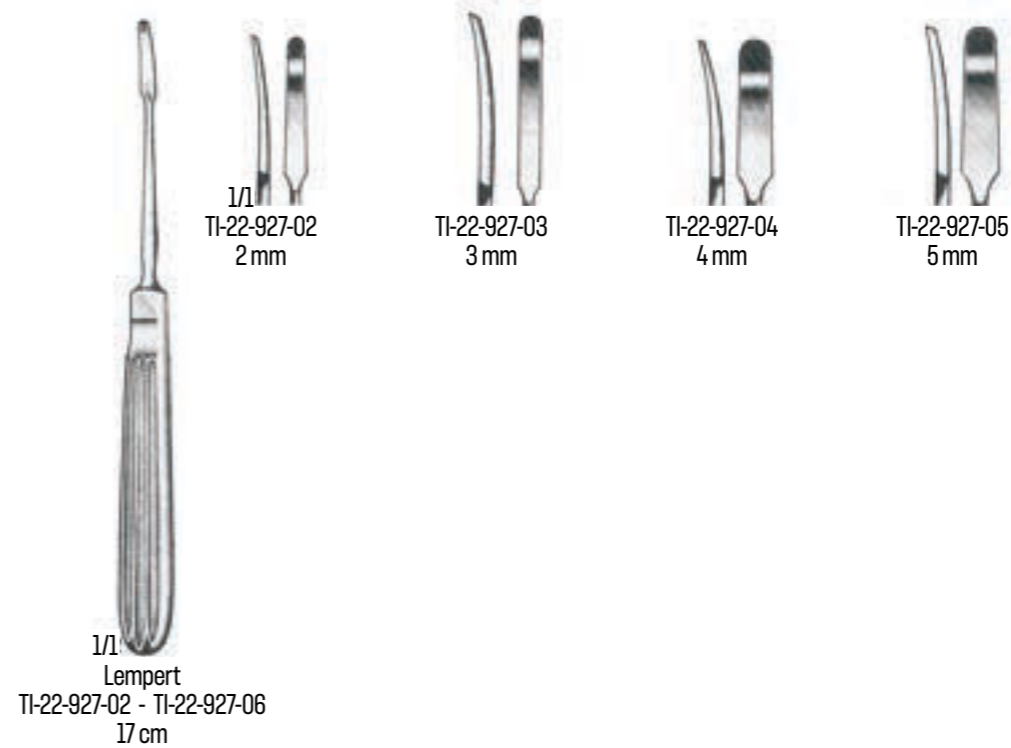
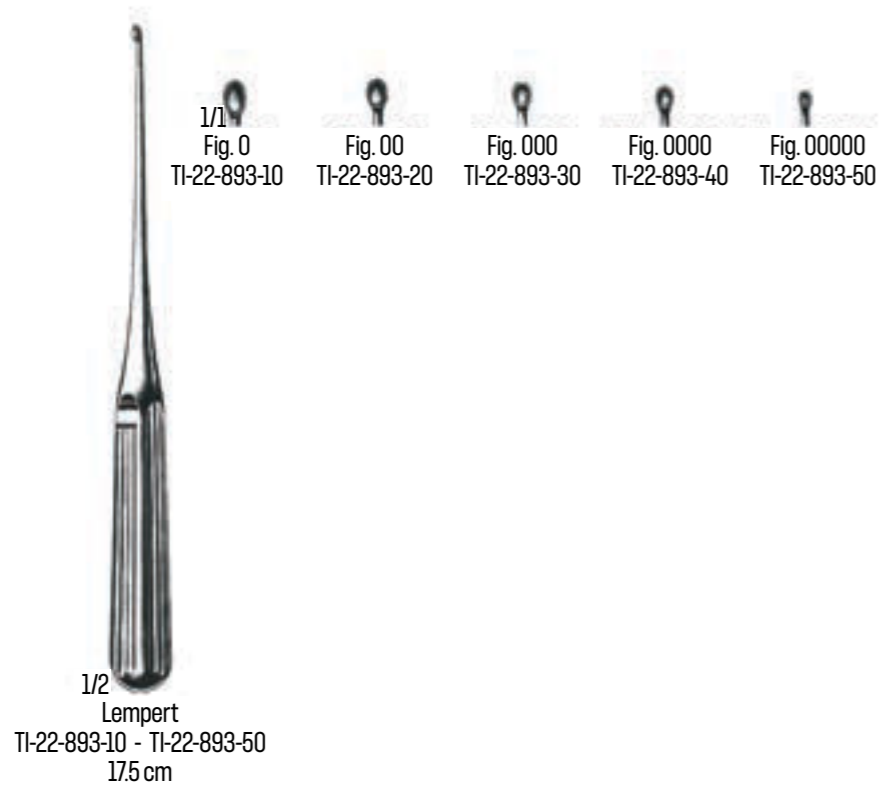
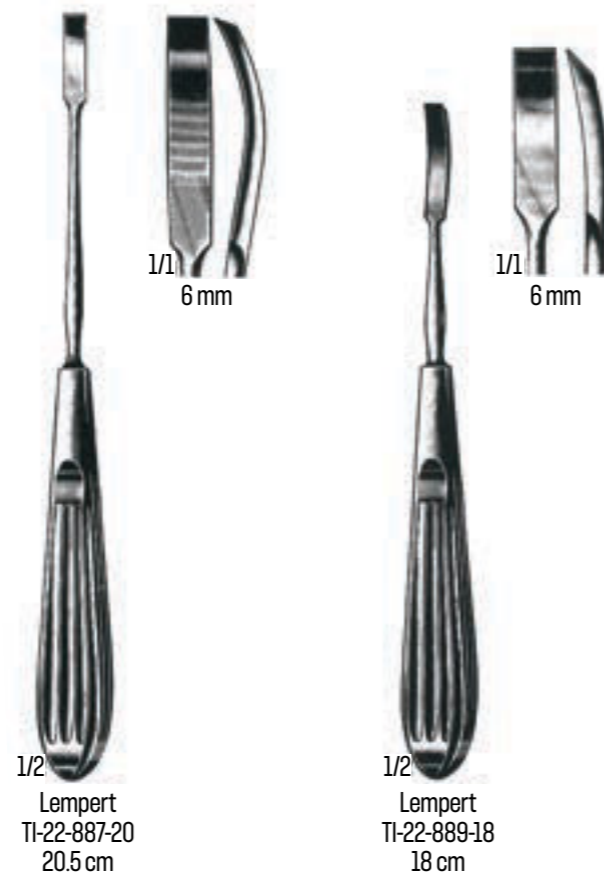
Quire  
 TI-22-636-10  
 10.5 cm

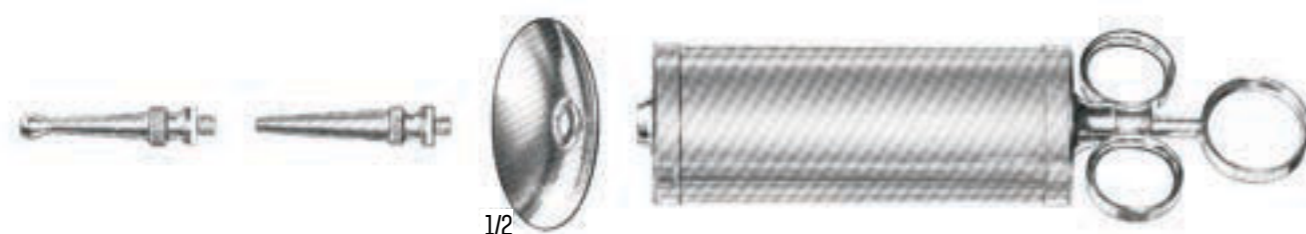




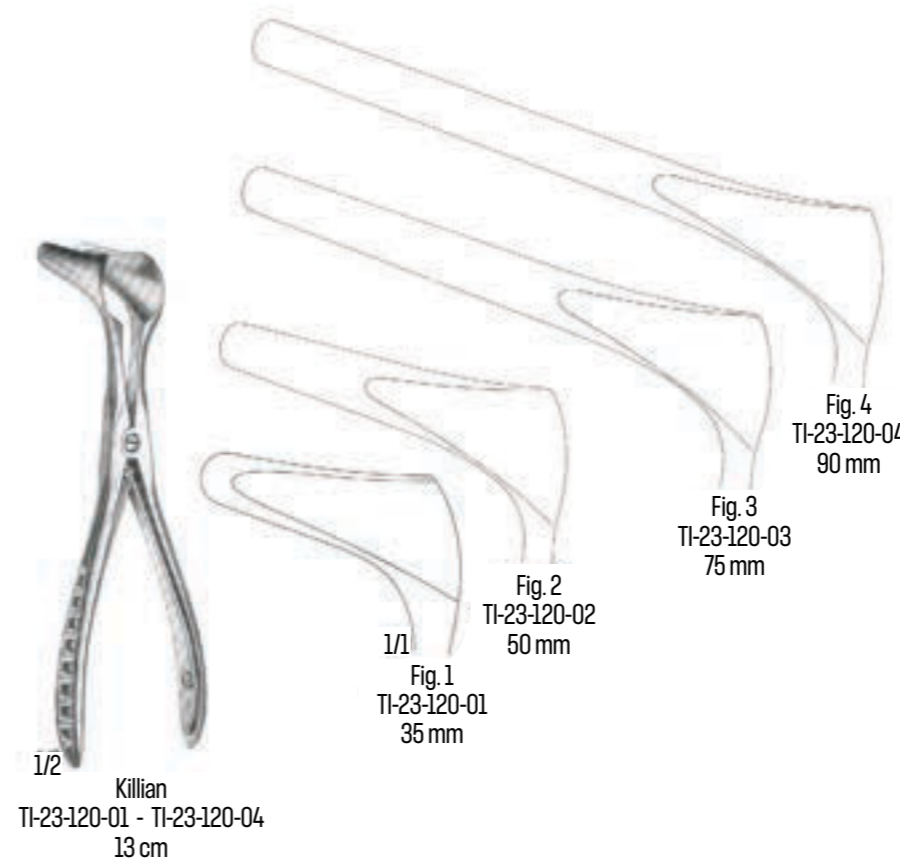
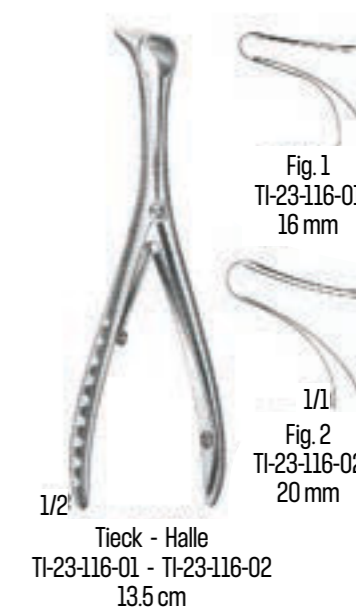








1/2  
 TI-22-945-00 50 ml  
 TI-22-945-04 100 ml  
 Ear Syringe, complete

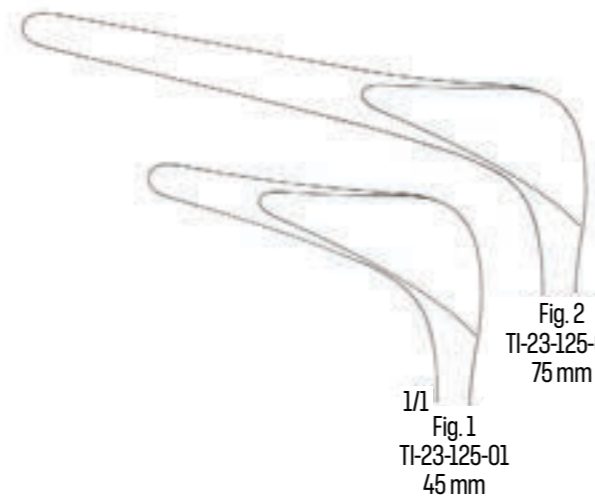




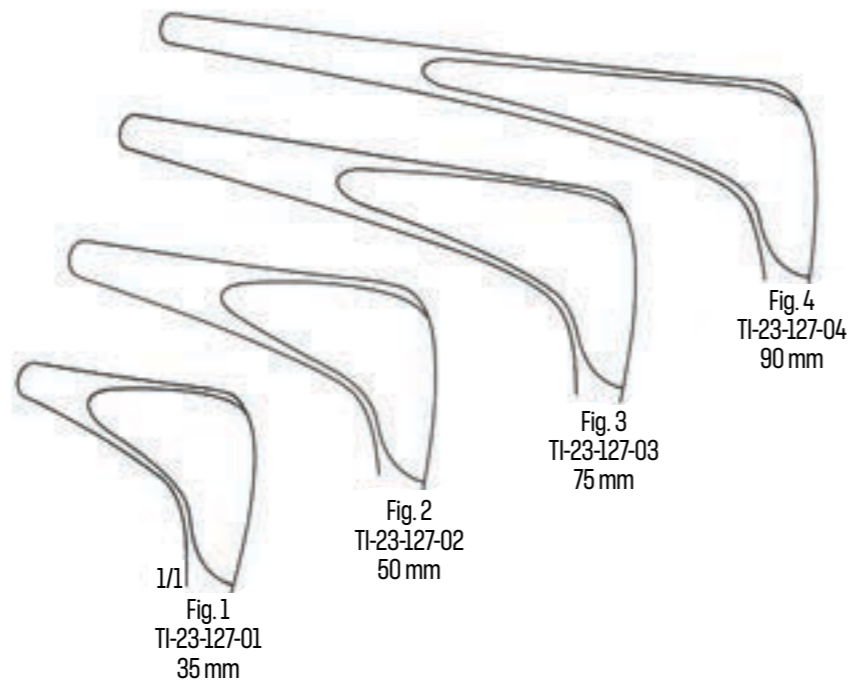
Dull black chromium plated



1/2  
 Cottle  
 TI-23-125-01 - TI-23-125-02  
 14 cm



1/1  
 Fig. 1  
 TI-23-125-01  
 45 mm  
 Fig. 2  
 TI-23-125-02  
 75 mm



1/1  
 Fig. 1  
 TI-23-127-01  
 35 mm  
 Fig. 2  
 TI-23-127-02  
 50 mm  
 Fig. 3  
 TI-23-127-03  
 75 mm  
 Fig. 4  
 TI-23-127-04  
 90 mm

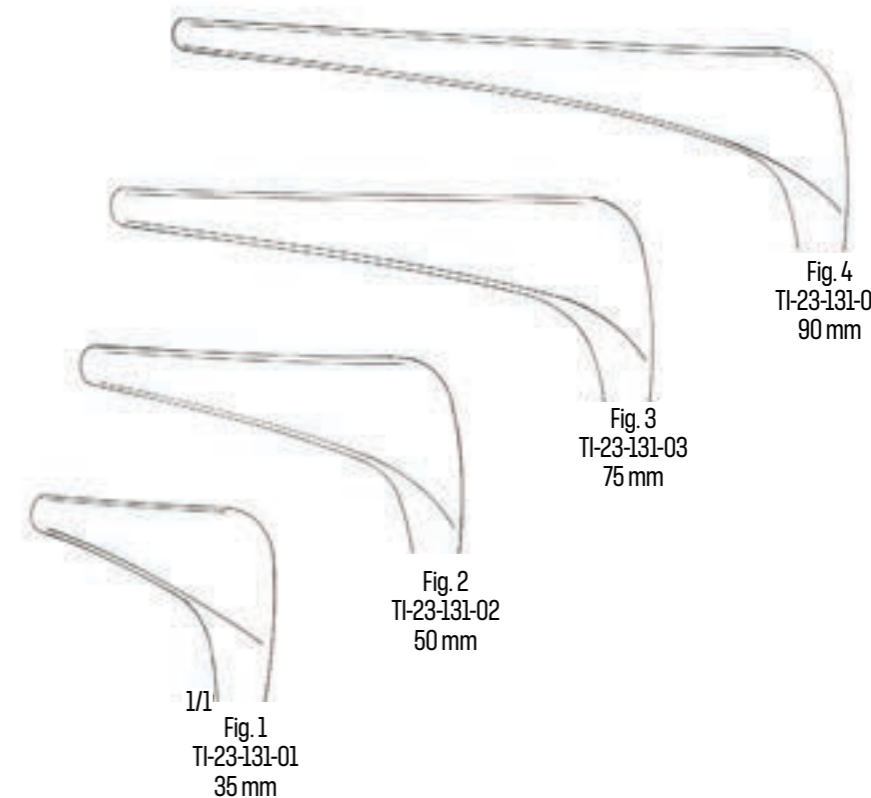


1/2  
 Cottle  
 TI-23-127-01 - TI-23-127-04  
 15 cm

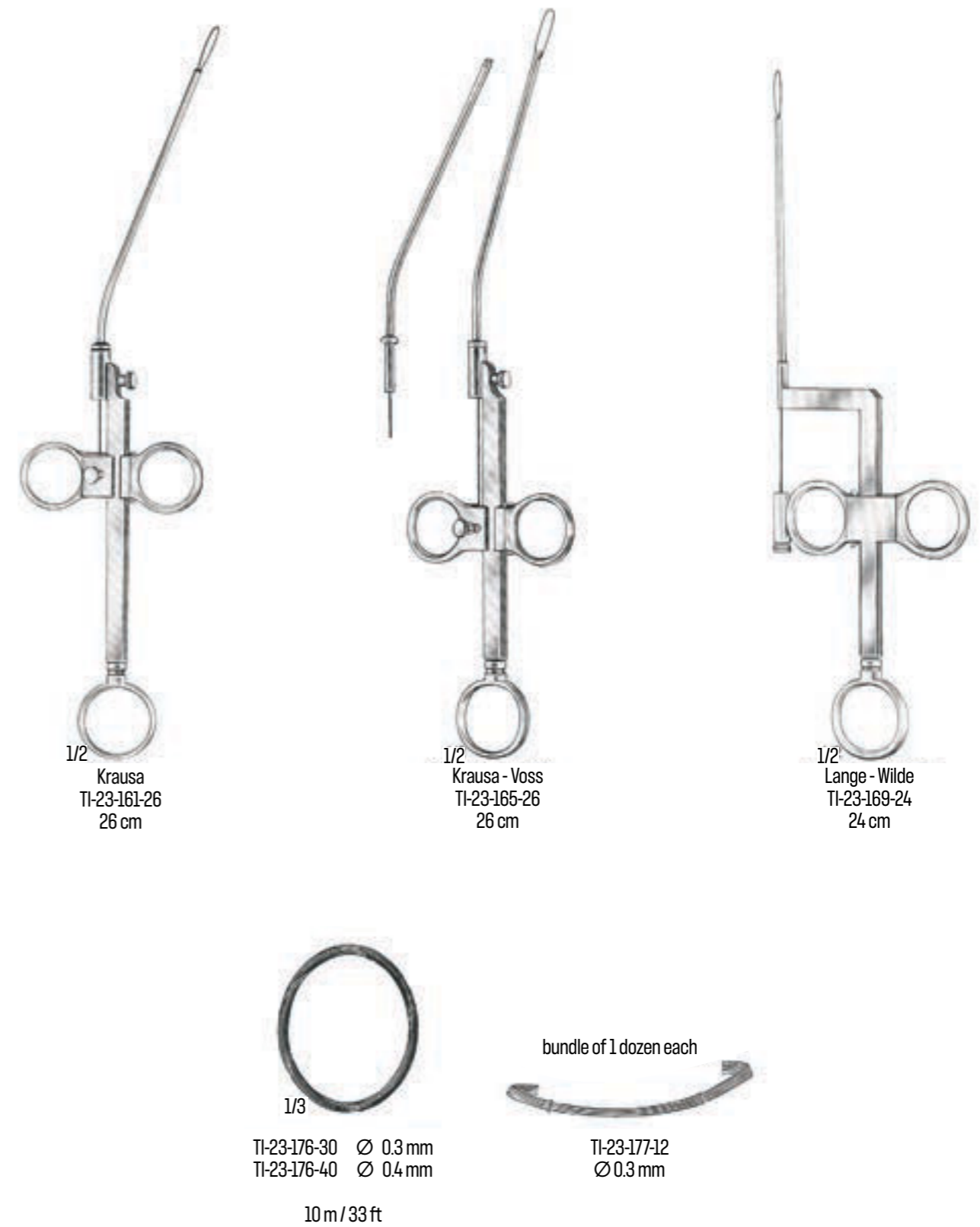
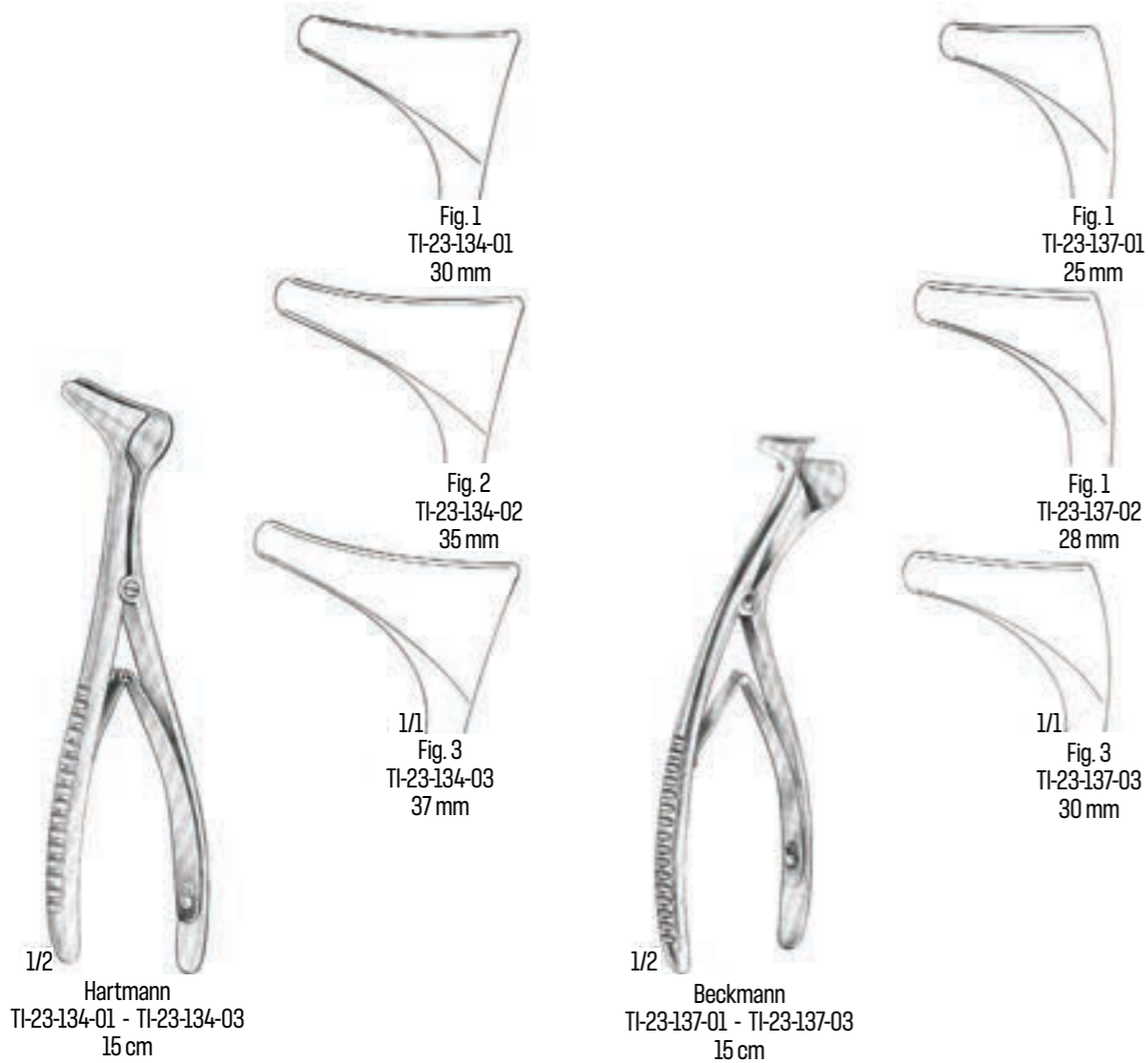
with fixing screw

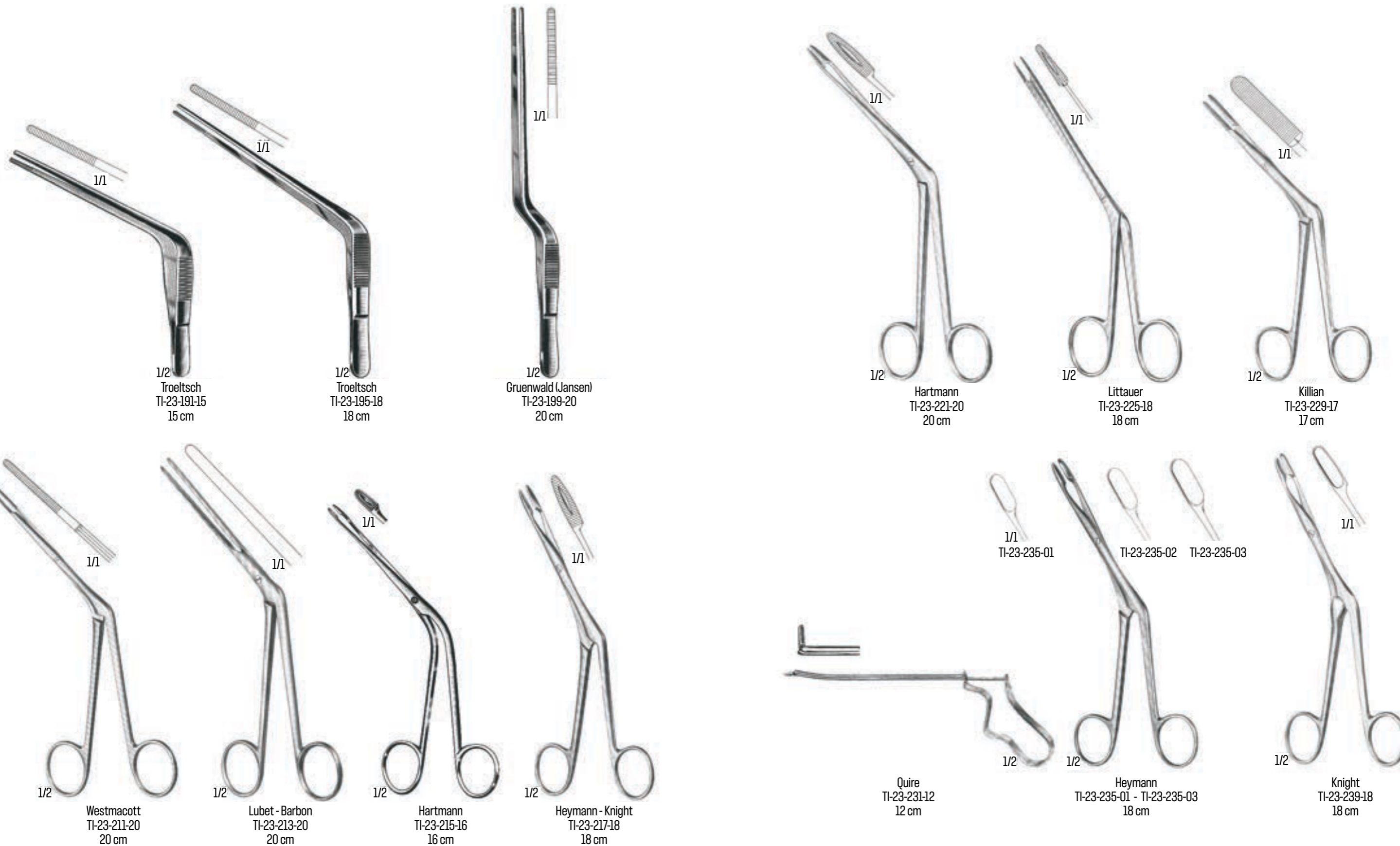


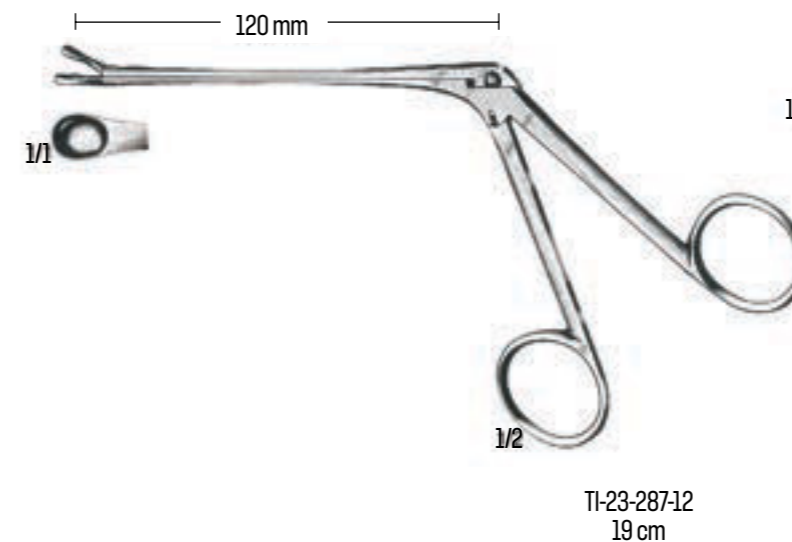
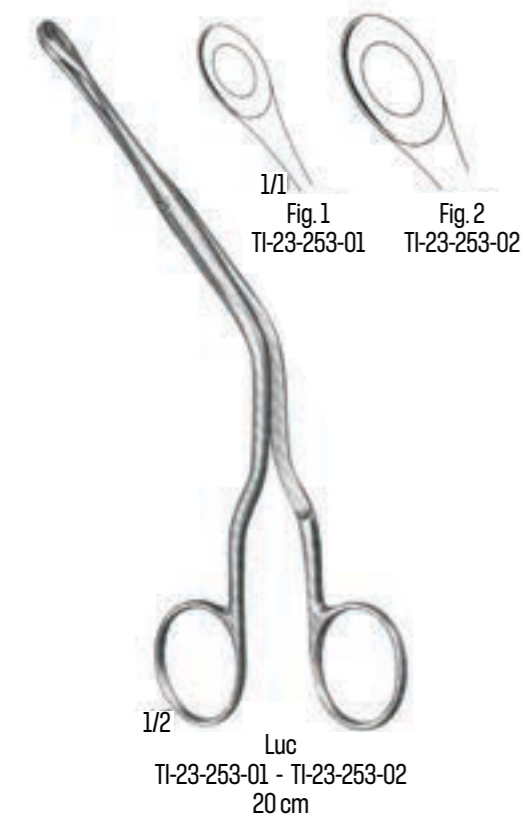
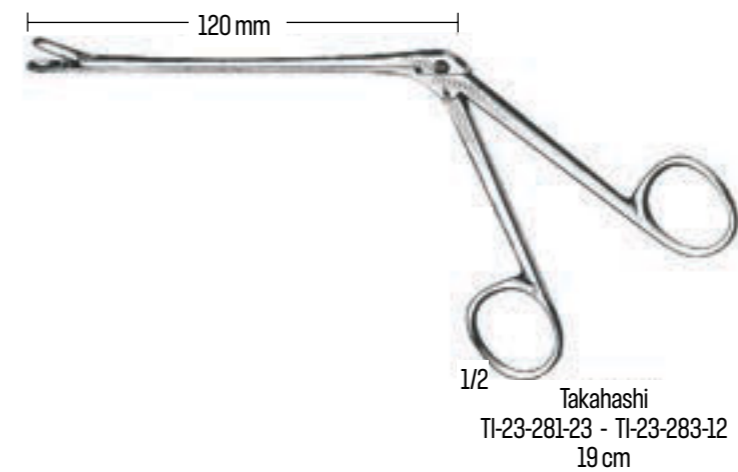
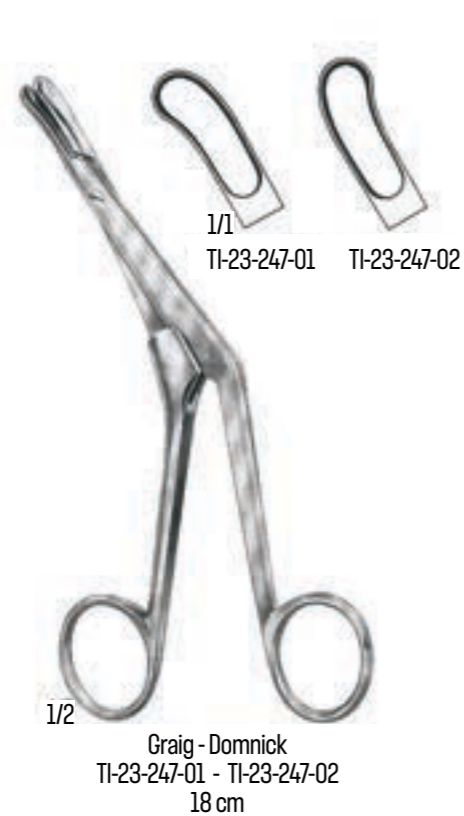
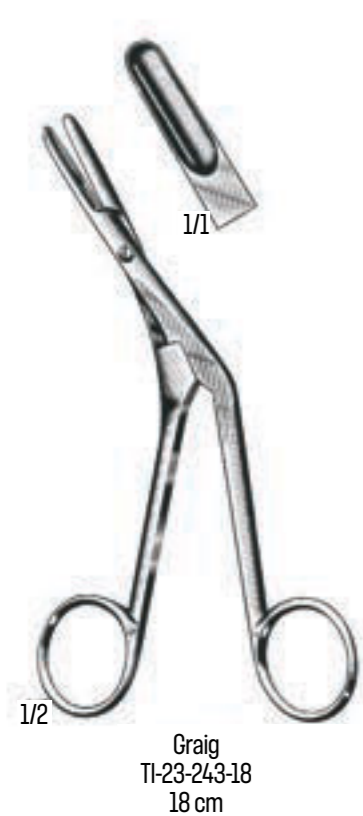
1/2  
 Cottle  
 TI-23-131-01 - TI-23-131-04  
 15 cm

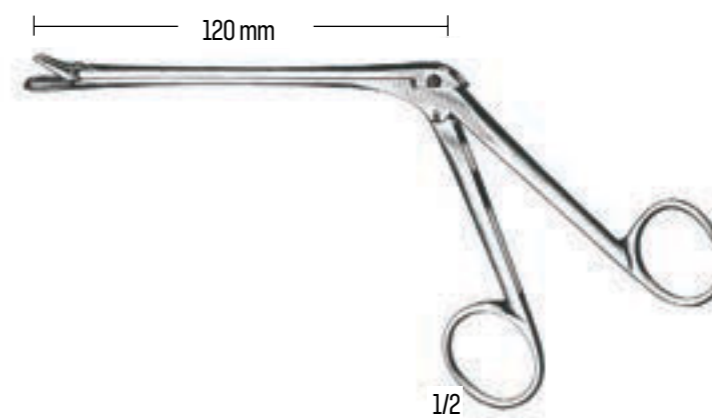
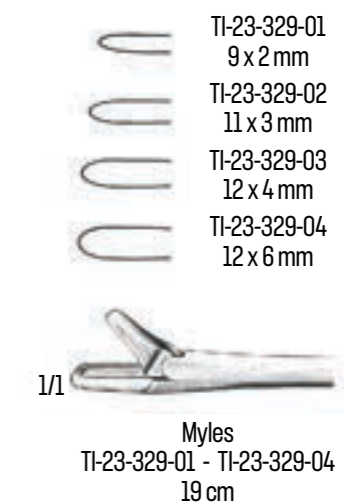
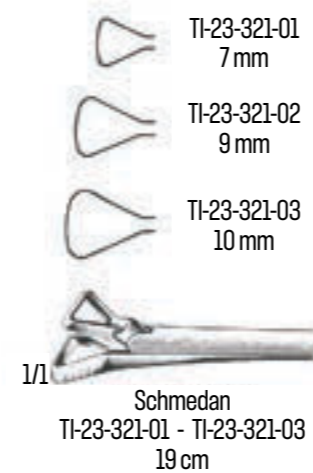
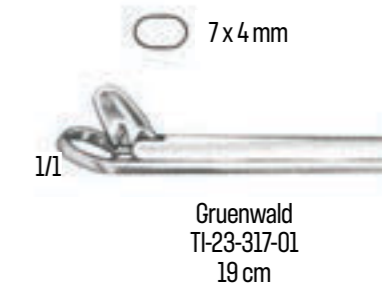
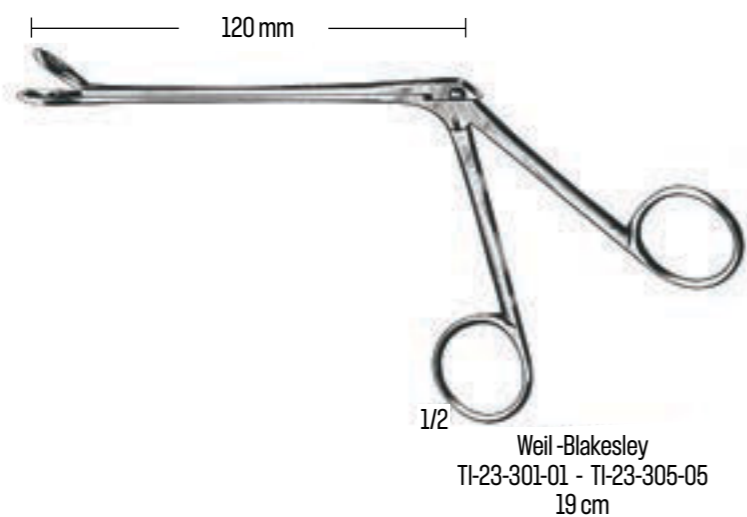


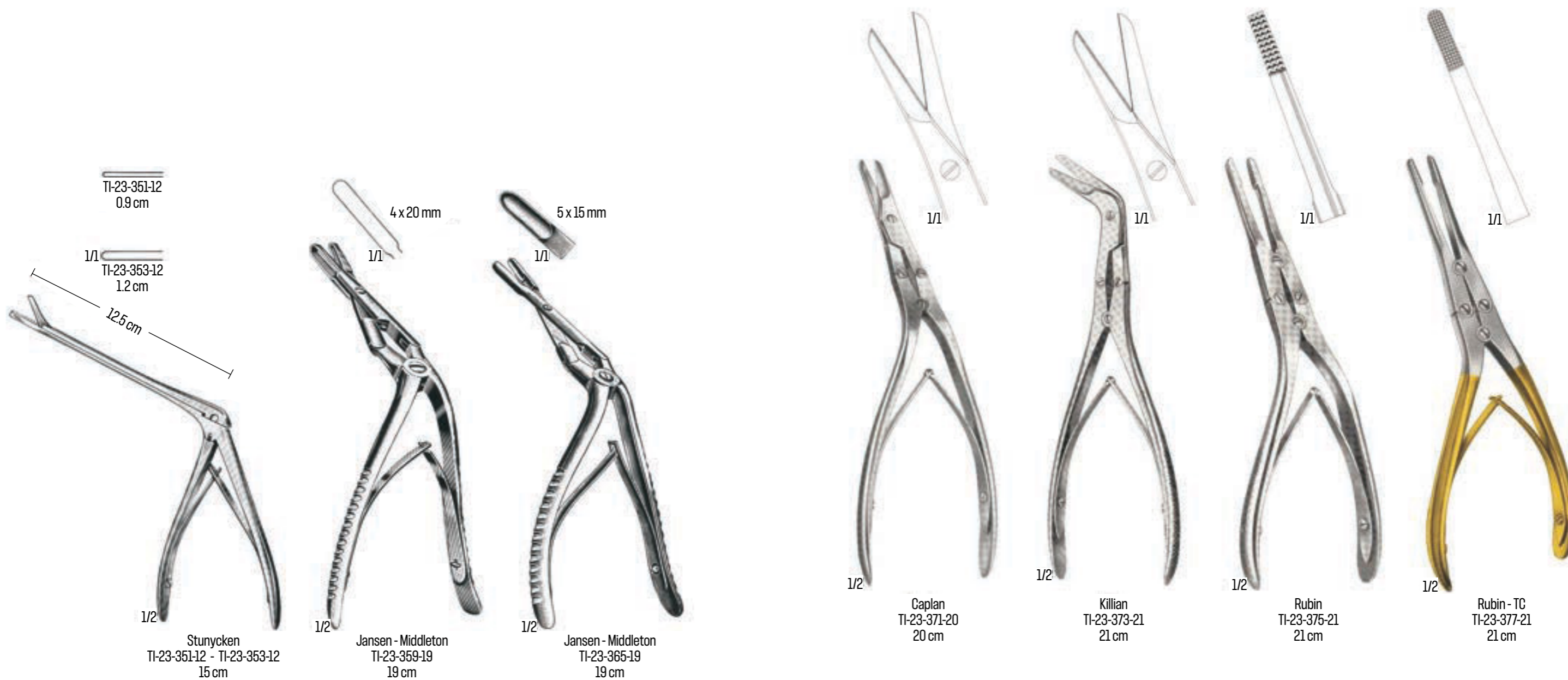
1/1  
 Fig. 1  
 TI-23-131-01  
 35 mm  
 Fig. 2  
 TI-23-131-02  
 50 mm  
 Fig. 3  
 TI-23-131-03  
 75 mm  
 Fig. 4  
 TI-23-131-04  
 90 mm

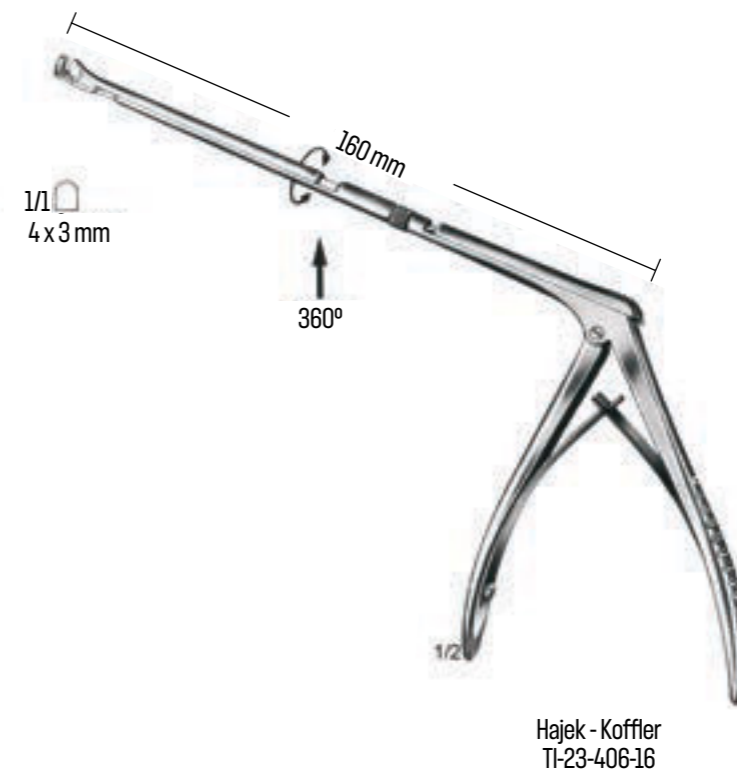
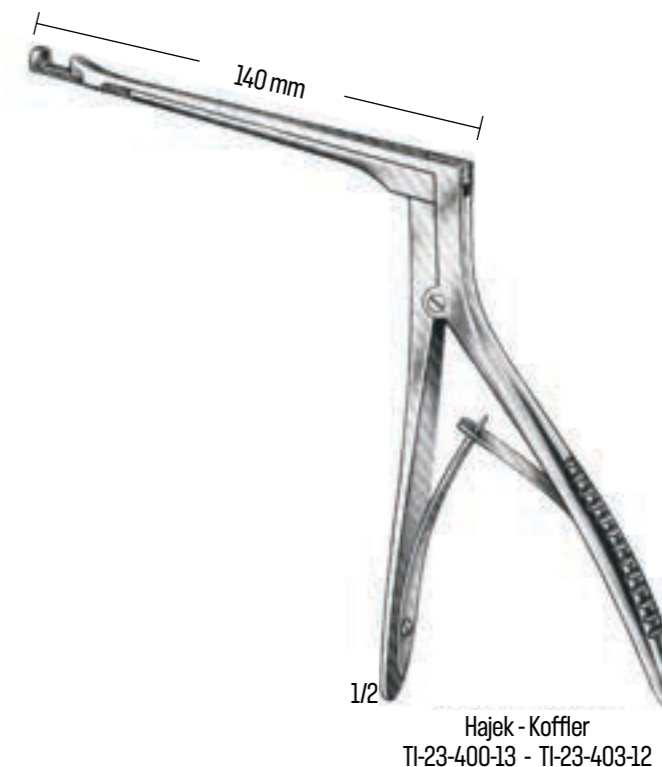
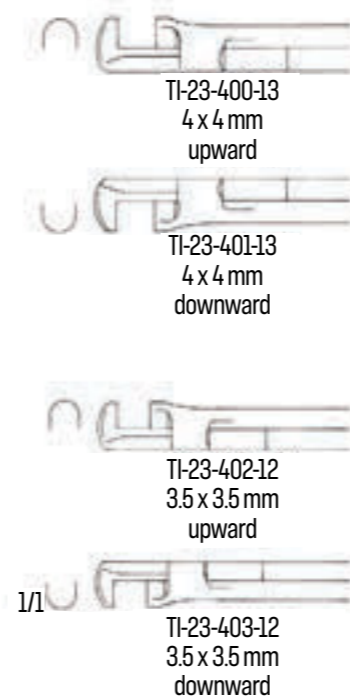
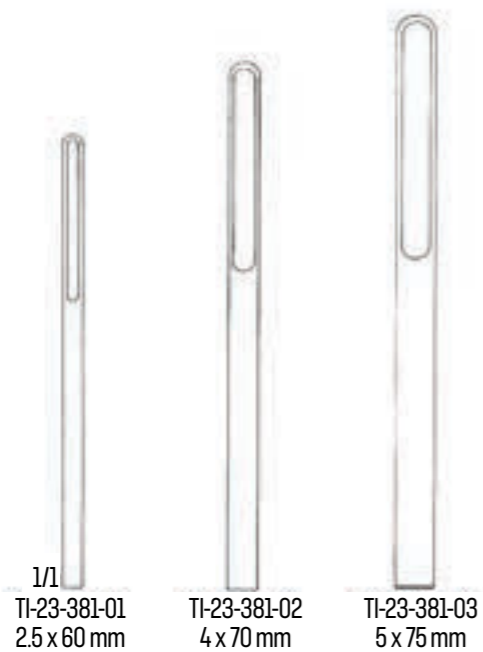


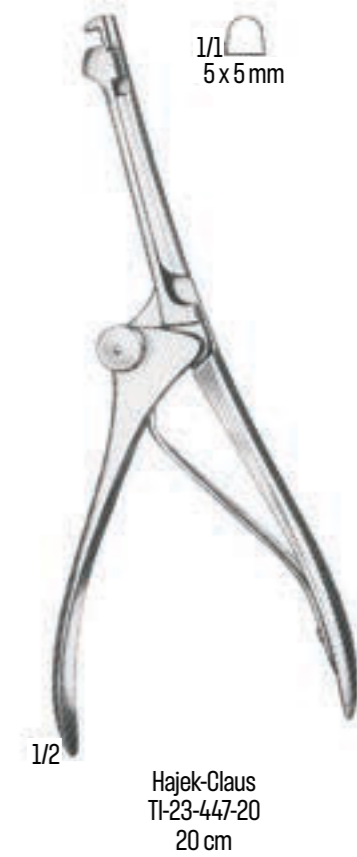
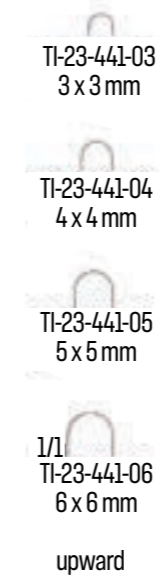
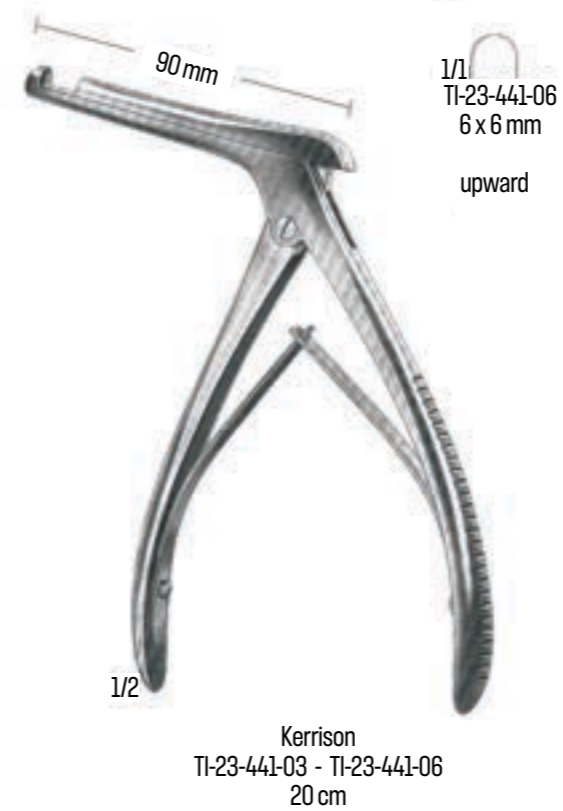
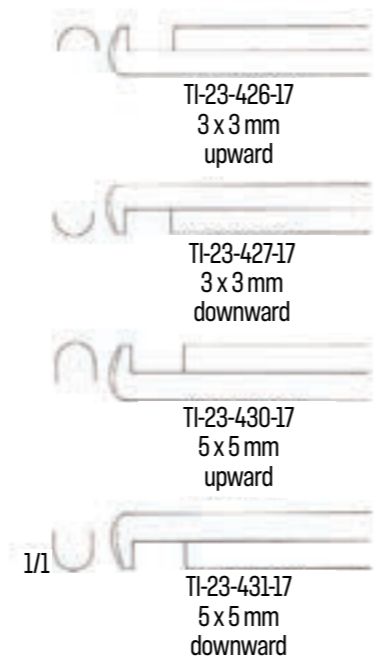
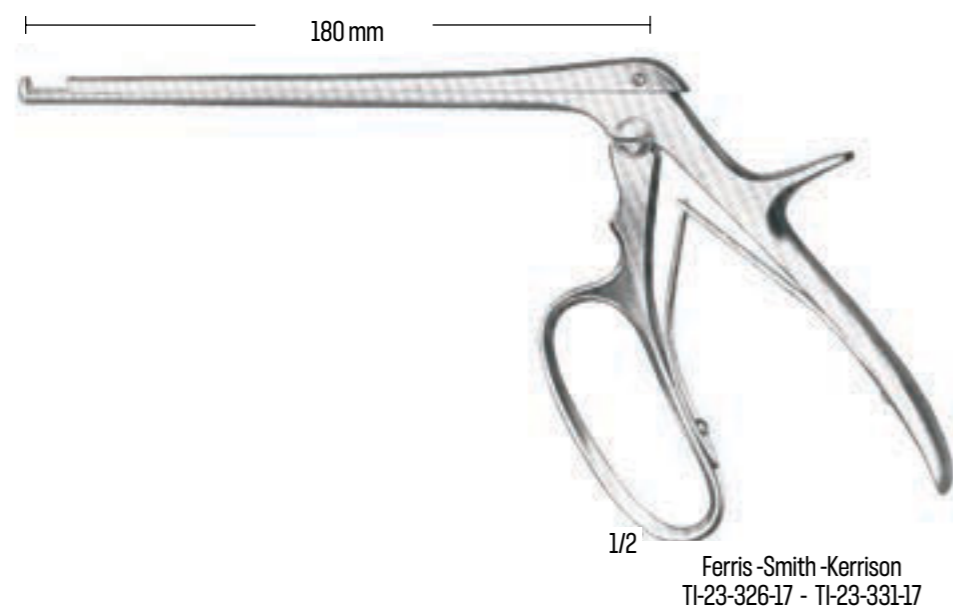
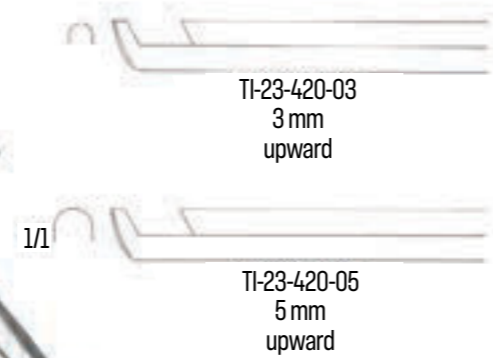
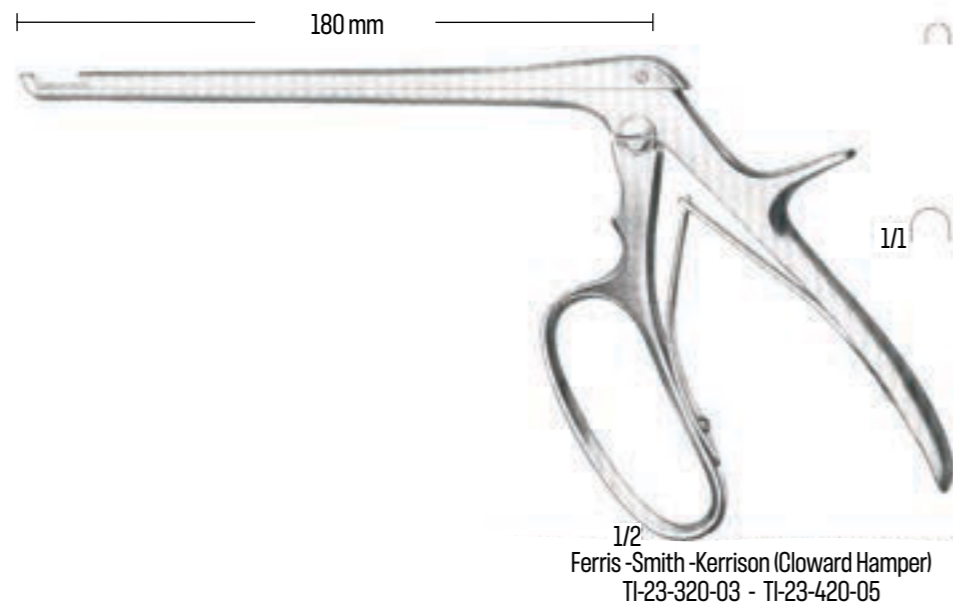




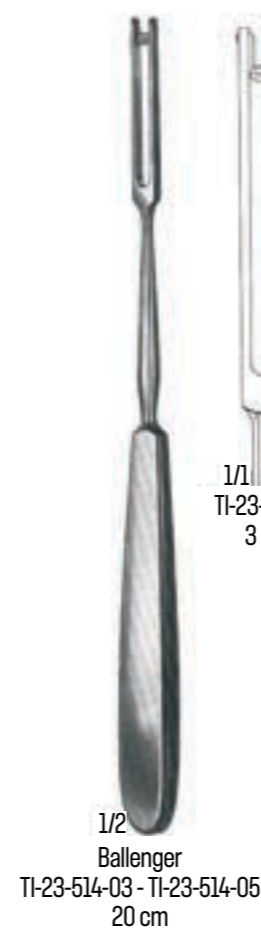


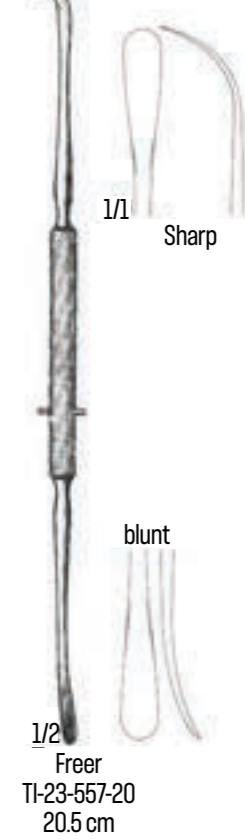
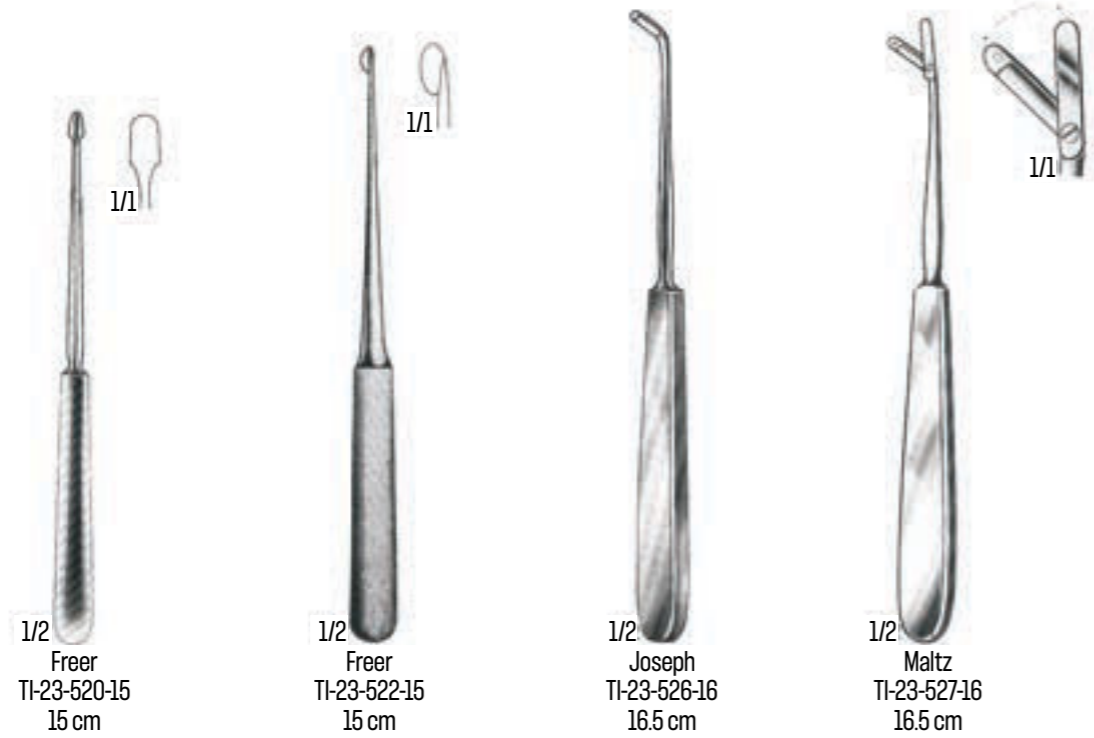


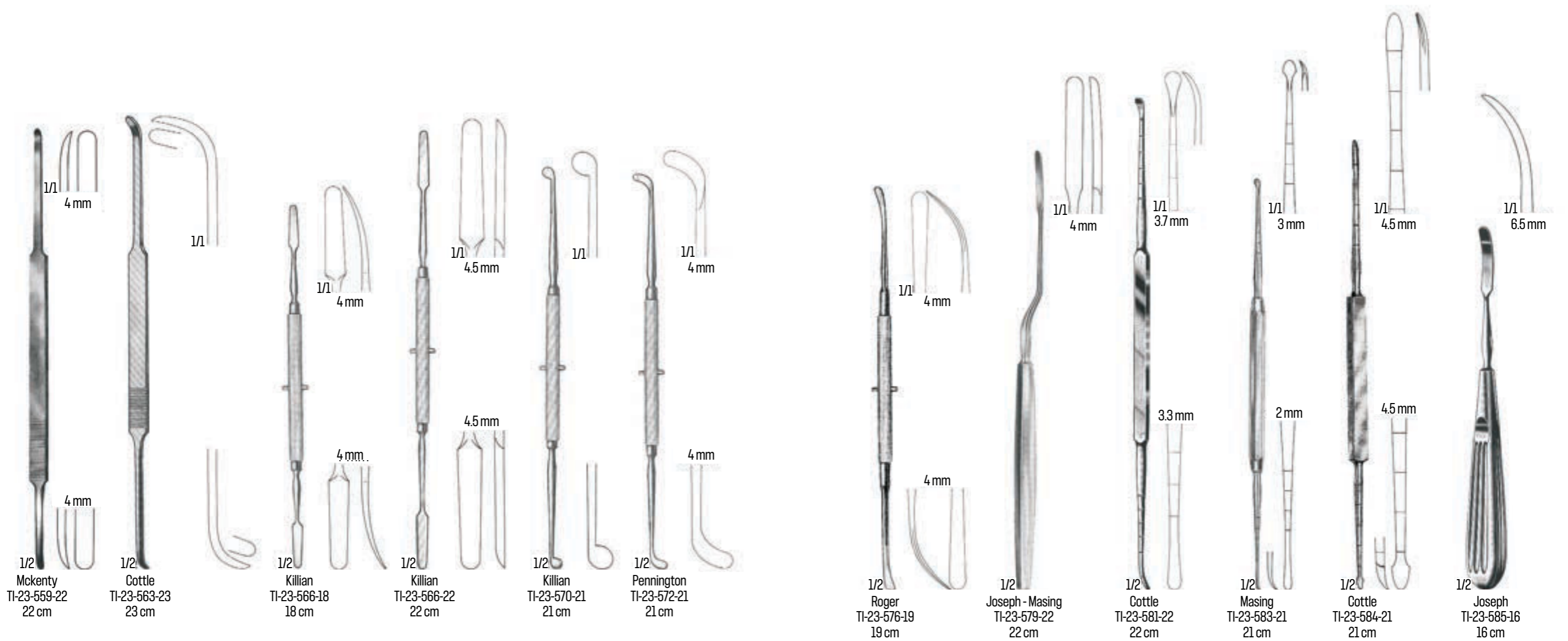




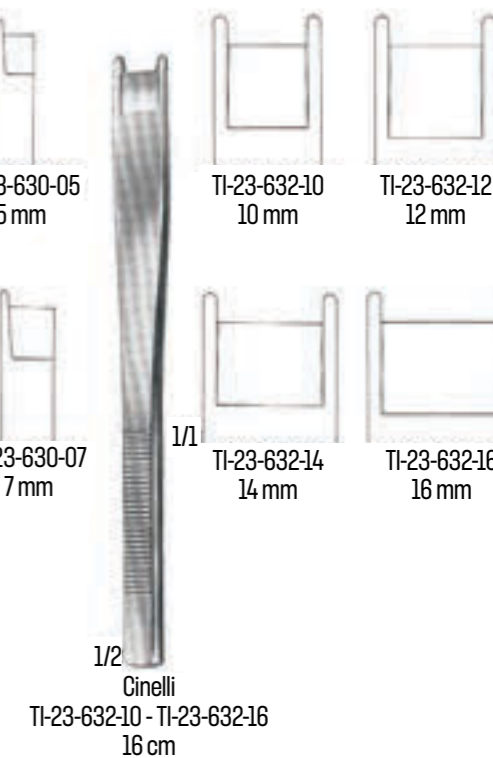
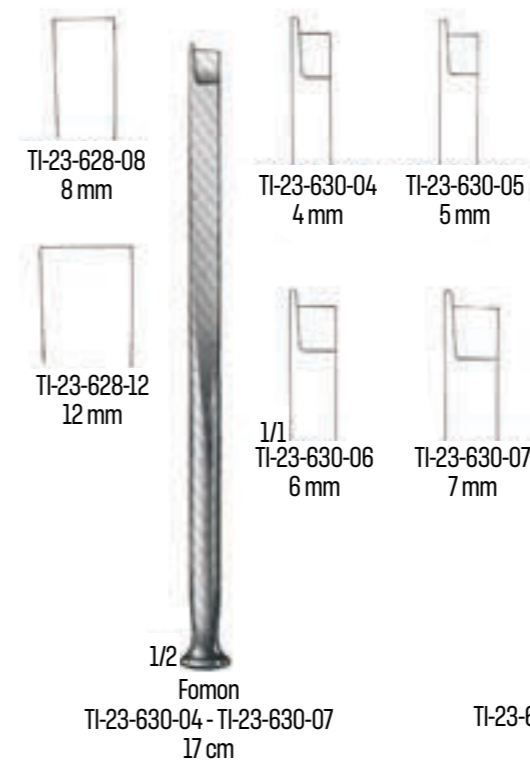
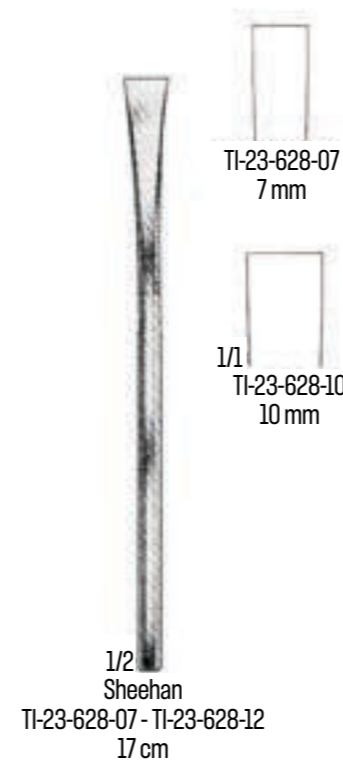
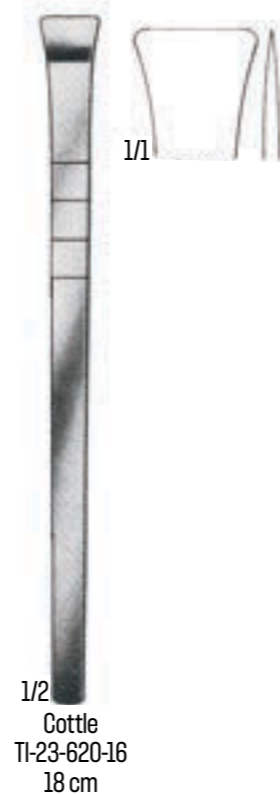
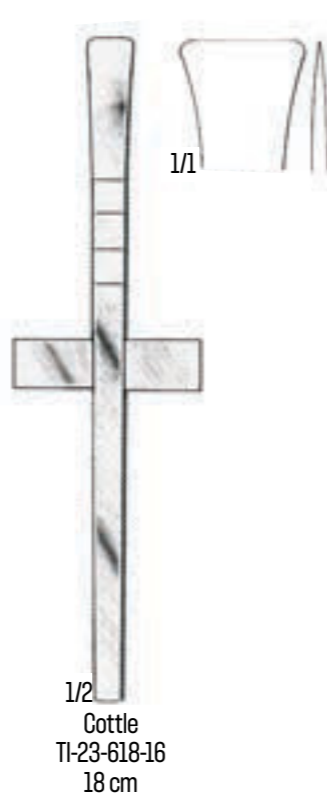
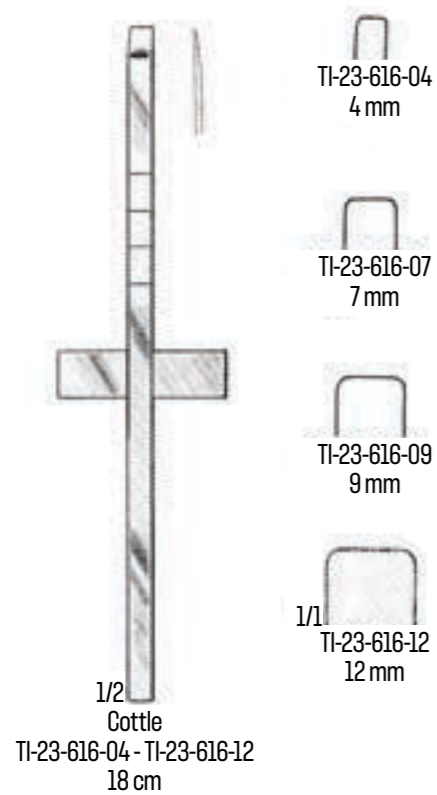
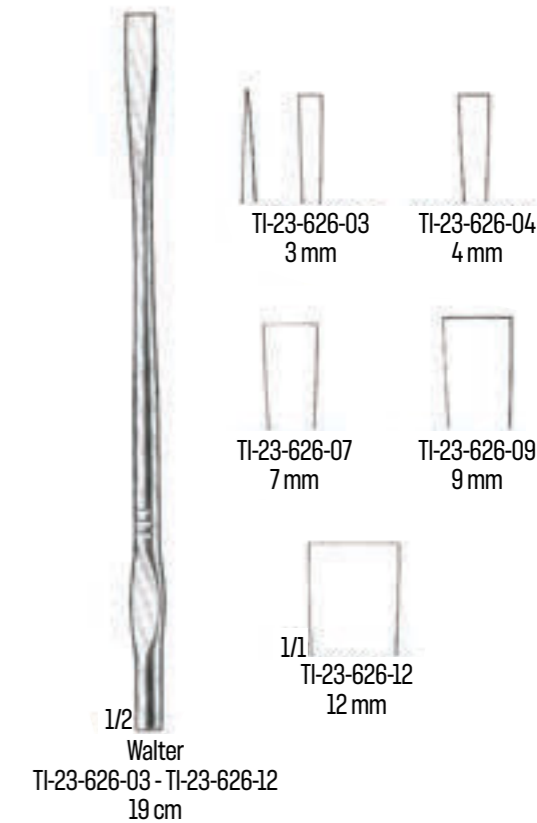
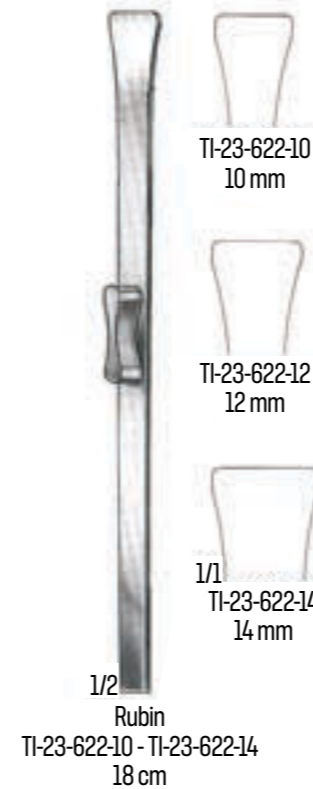


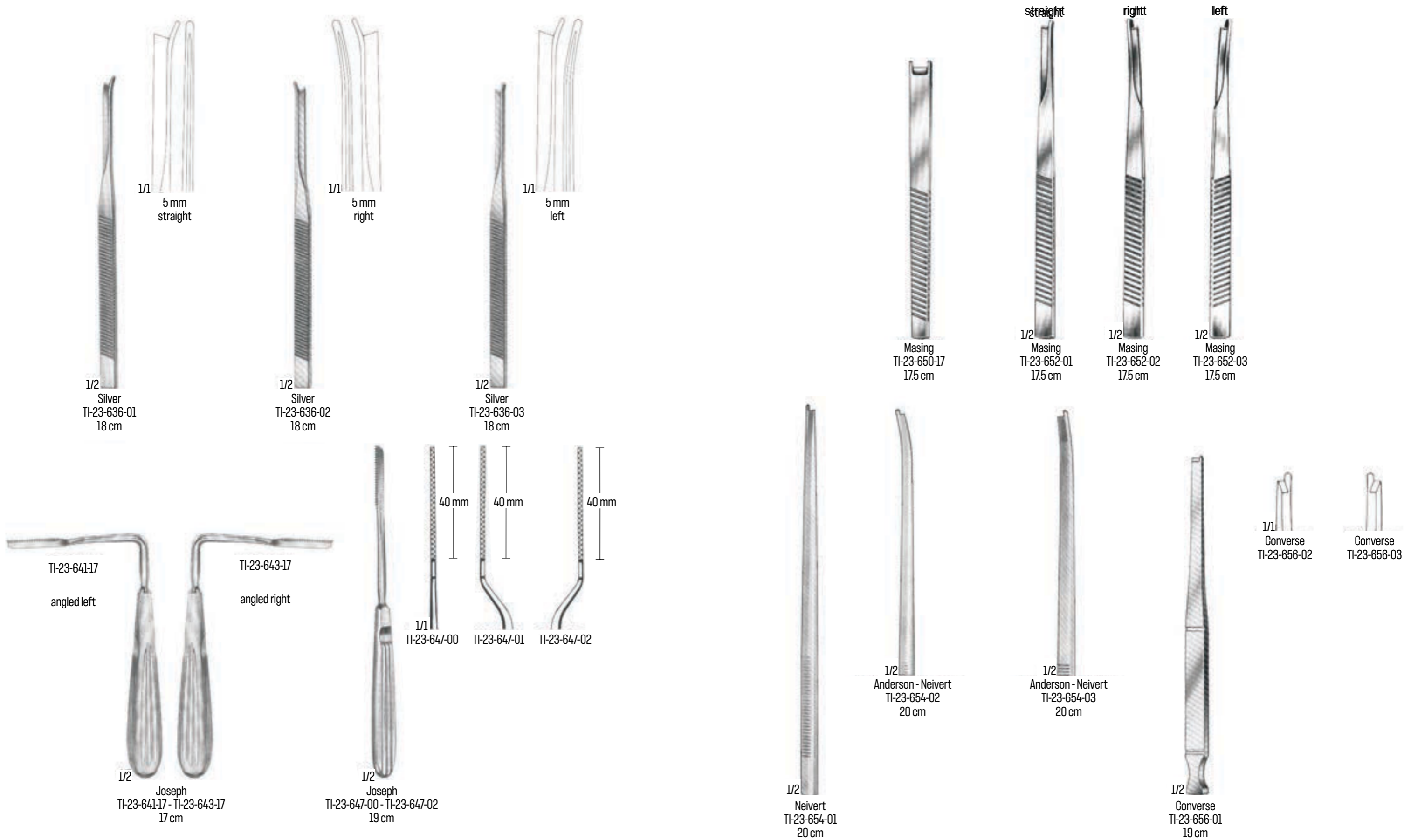


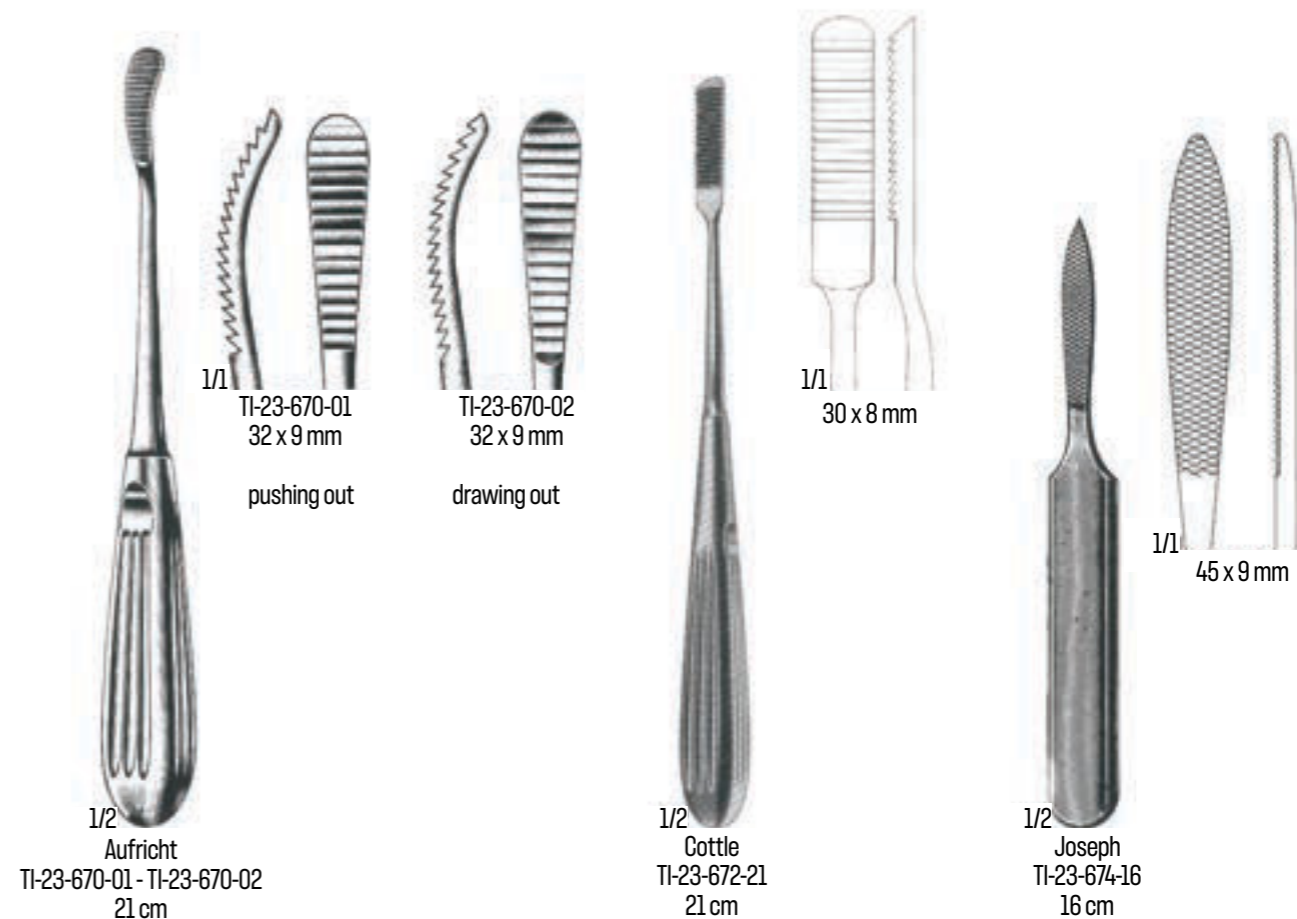
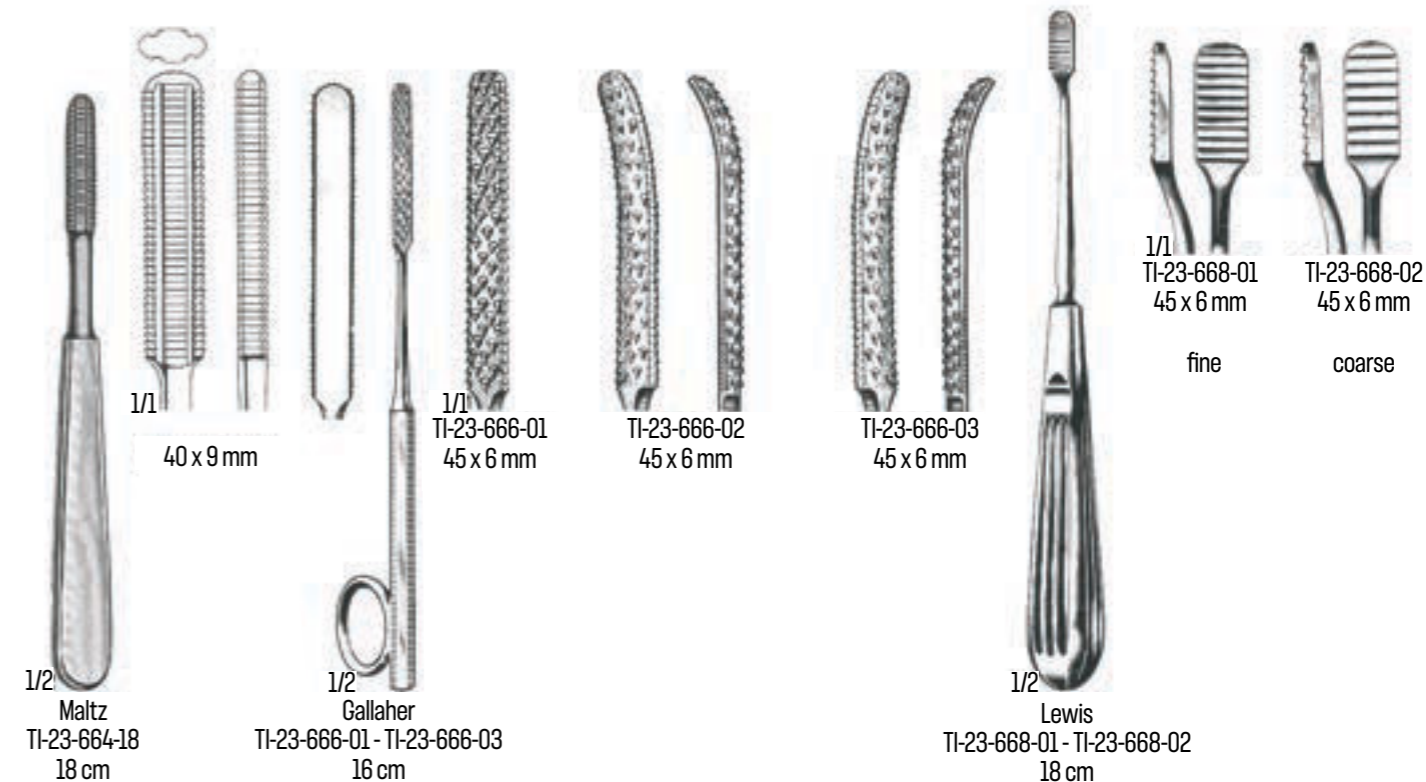
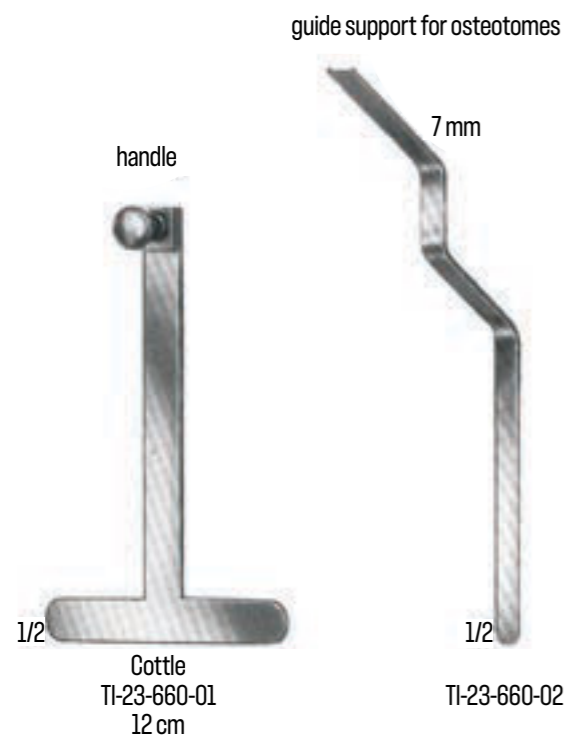


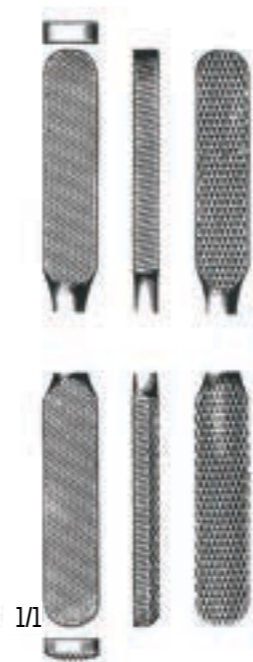




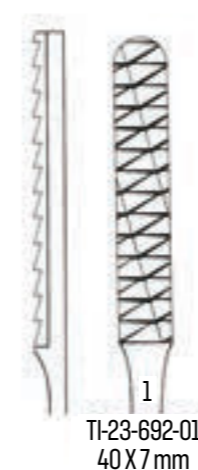


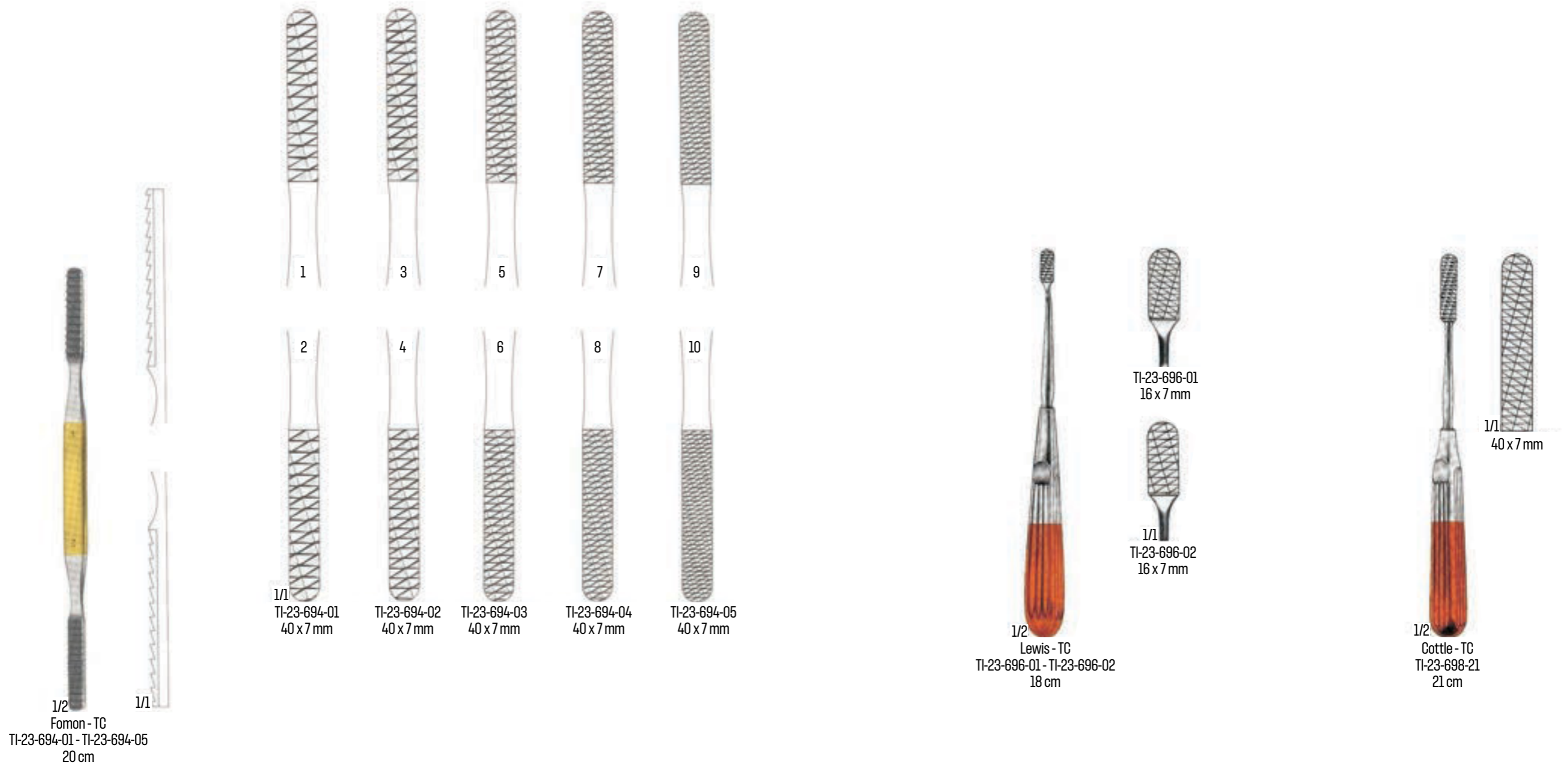


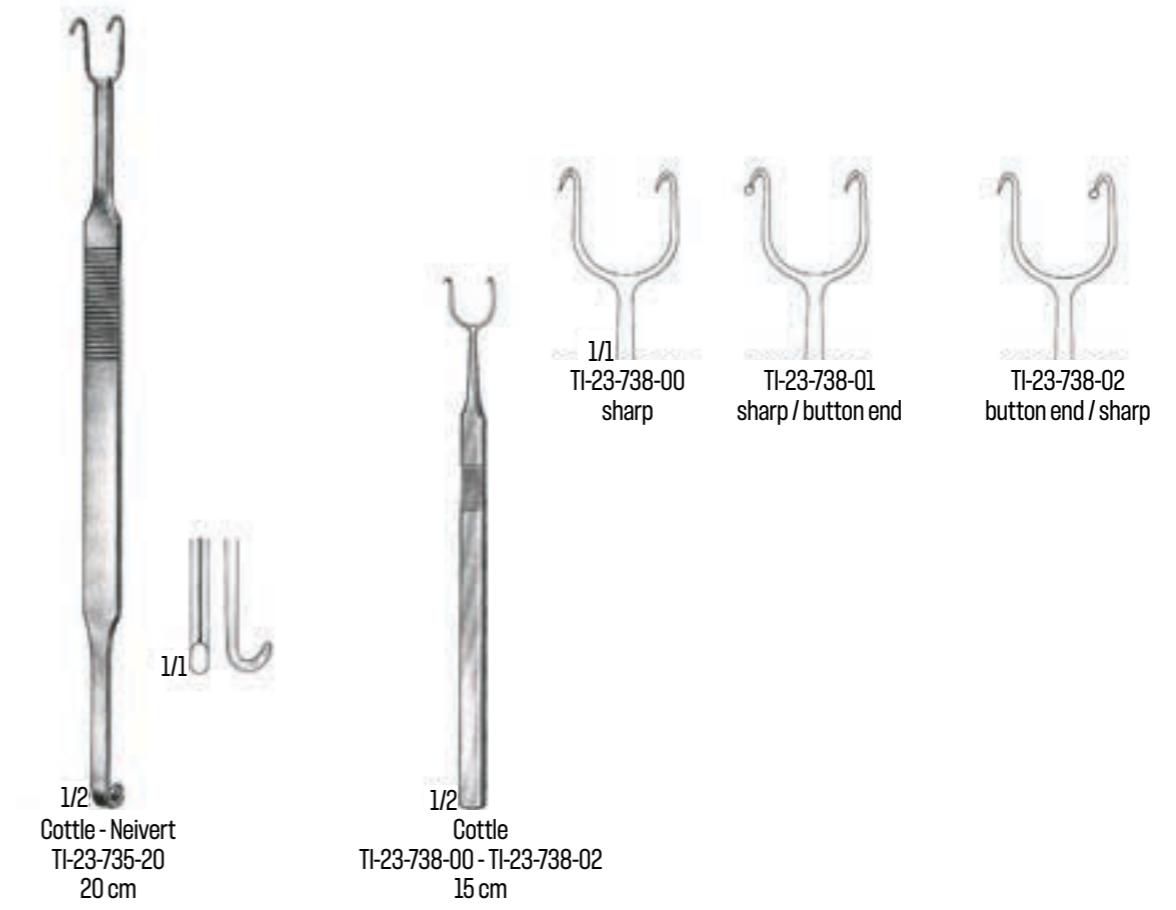
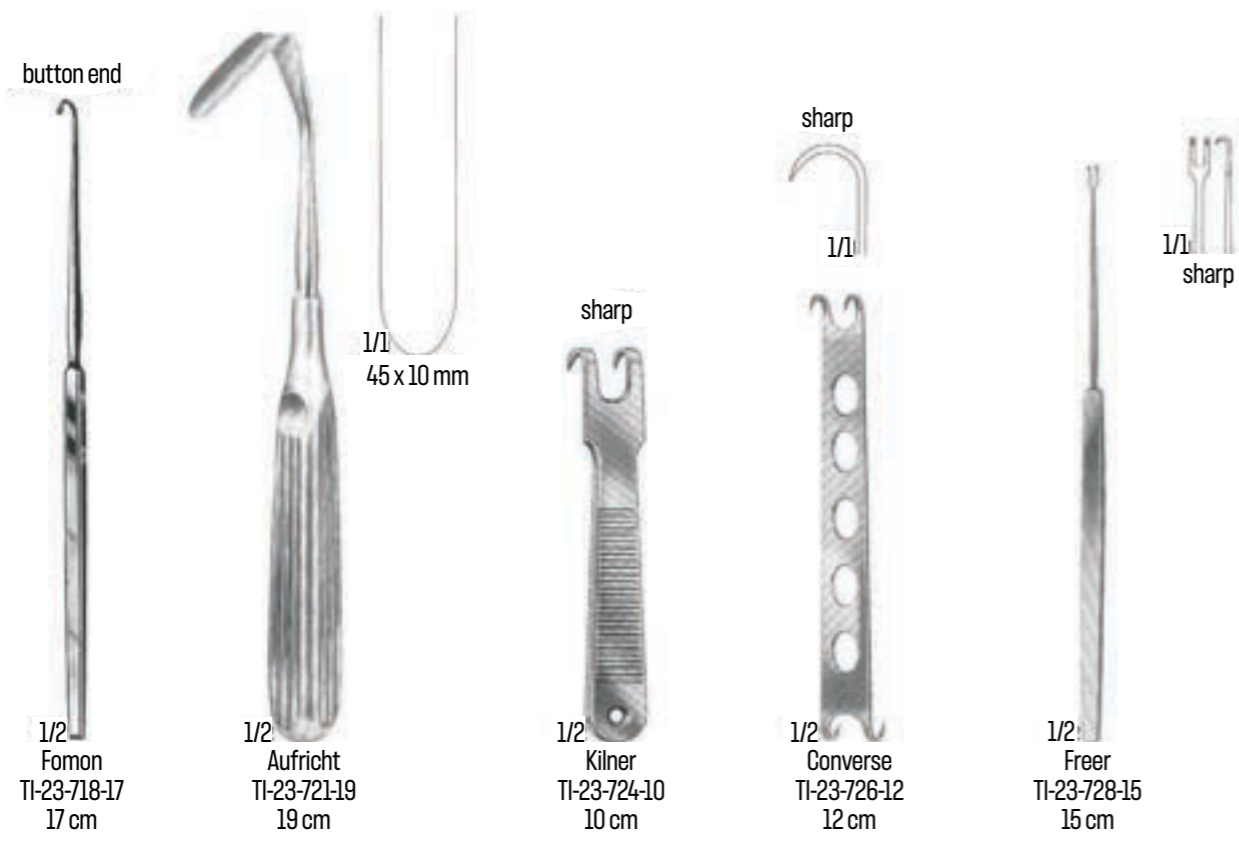
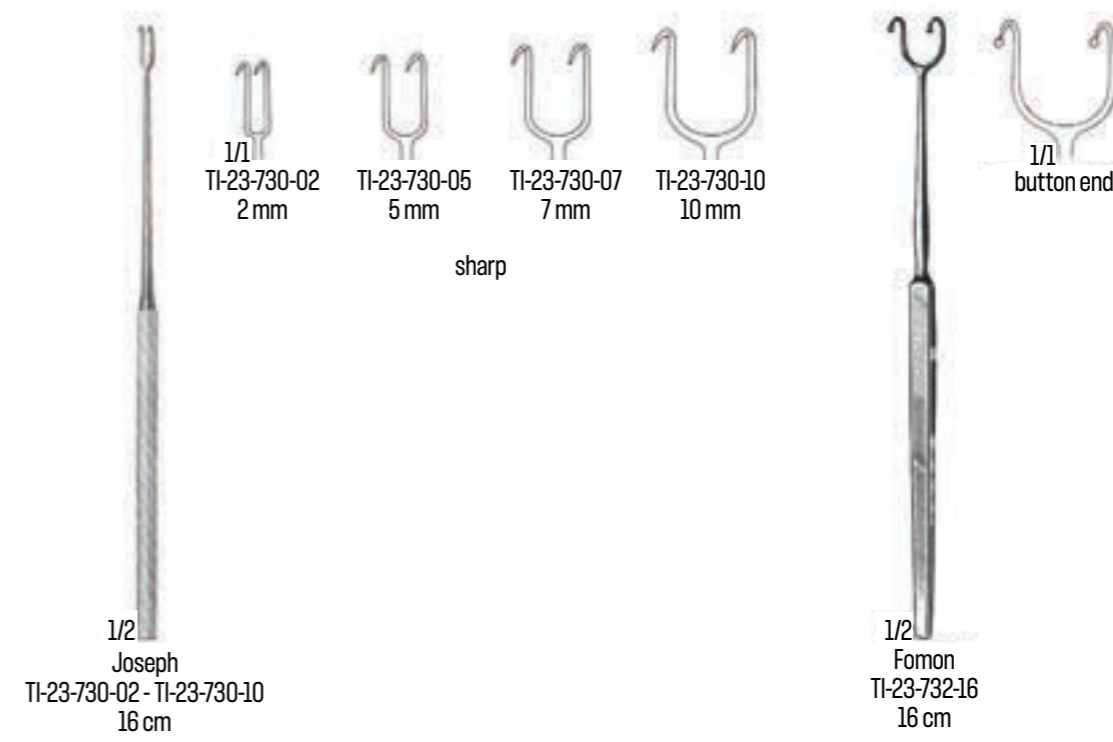
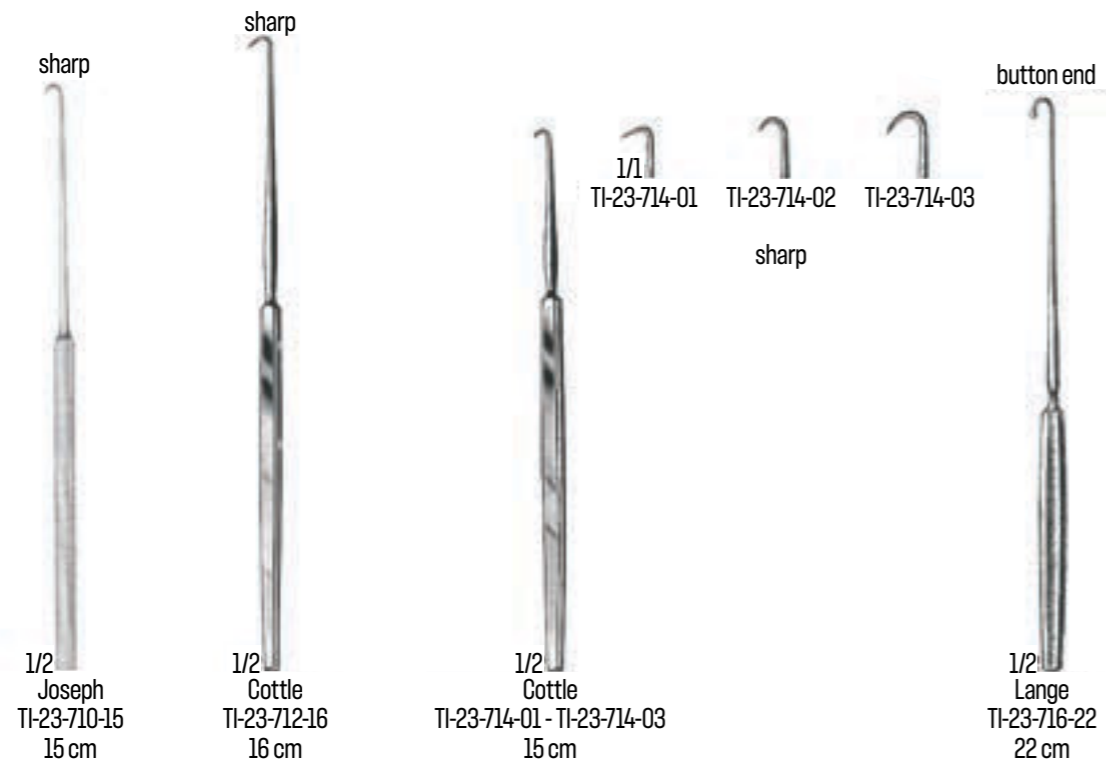














1/2  
Cottle  
TI-23-740-14  
14 cm



1/2  
Neivert  
TI-23-742-16  
16 cm



1/2  
Cottle  
TI-23-744-15  
15 cm



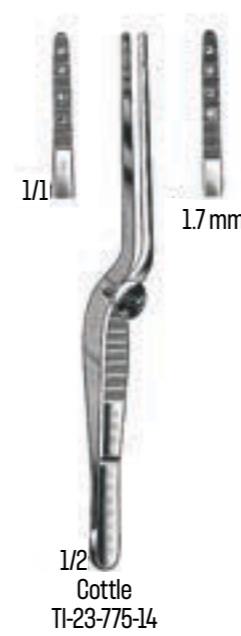
1/2  
Cottle  
TI-23-746-15  
15 cm



60 x 6.5 mm  
blunt  
1/2  
Aufricht  
TI-23-749-13  
13.5 cm



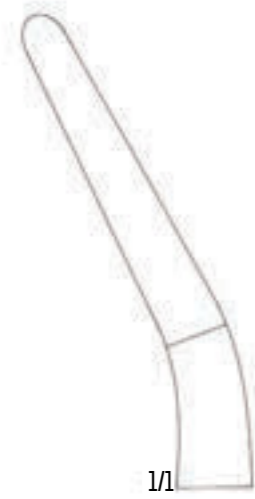
1/1  
4 mm  
1/2  
Ogura  
TI-23-770-11



1/1  
1.7 mm  
1/2  
Cottle  
TI-23-775-14



1/2  
Cottle (Columella)  
TI-23-778-10



1/1



1/1  
 TI-23-806-01  
 straight



TI-23-806-02  
 left



TI-23-806-03  
 right



1/2  
 Asch  
 TI-23-801-23  
 23 cm



1/2  
 Walsham  
 TI-23-806-01 - TI-23-806-03  
 23 cm



1/2  
 Cottle - Walsham  
 TI-23-810-22  
 22 cm



1/2  
 Faulkner  
 TI-23-830-21  
 21 cm



1/2  
 Coakley  
 TI-23-841-01 - TI-23-841-06  
 17 cm



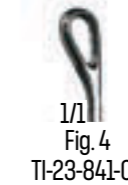
Fig. 1  
 TI-23-841-01



Fig. 2  
 TI-23-841-02



Fig. 3  
 TI-23-841-03



1/1  
 Fig. 4  
 TI-23-841-04



Fig. 5  
 TI-23-841-05



Fig. 6  
 TI-23-841-06

adenoides



Fig. 1  
 TI-23-860-01  
 TI-23-861-01  
 13 mm



Fig. 2  
 TI-23-860-02  
 TI-23-861-02  
 15 mm



Fig. 3  
 TI-23-860-03  
 TI-23-861-03  
 17 mm



1/1  
 Fig. 4  
 TI-23-860-04  
 TI-23-861-04  
 21 mm



Fig. 5  
 TI-23-860-05  
 TI-23-861-05  
 23 mm



Fig. 6  
 TI-23-860-06  
 TI-23-861-06  
 23 mm



1/2  
 Beckmann  
 TI-23-860-01 - TI-23-860-03  
 22 cm



1/2  
 Beckmann  
 TI-23-861-01 - TI-23-861-06  
 22 cm



TI-23-866-01  
 13 mm



TI-23-866-02  
 15 mm



TI-23-866-03  
 17 mm



1/1  
 TI-23-866-04  
 19 mm



1/2  
 Bamhill  
 TI-23-866-01 - TI-23-866-04  
 22 cm



TI-23-870-01  
 17 mm



TI-23-870-02  
 19 mm



TI-23-870-03  
 21 mm



1/1  
 TI-23-870-04  
 22 mm



1/2  
 St. Clair - Thompson  
 TI-23-870-01 - TI-23-870-04  
 21 cm

with unperforated blade



Fig. 1  
TI-23-880-01



Fig. 2  
TI-23-880-02



1/1  
Fig. 3  
TI-23-880-03

with perforated blade



Fig. 1  
TI-23-882-01

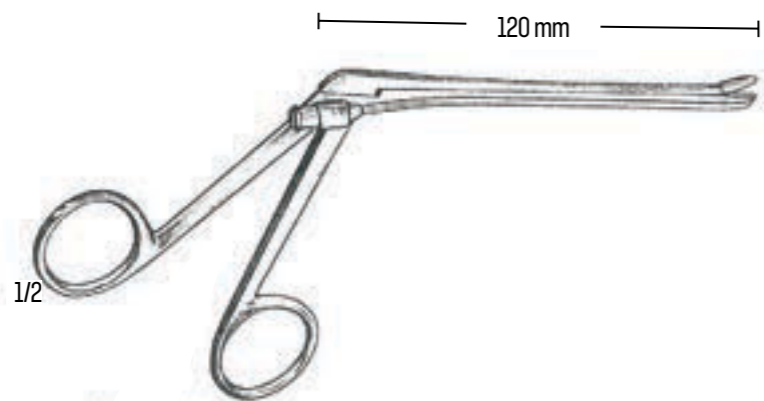


Fig. 2  
TI-23-882-02



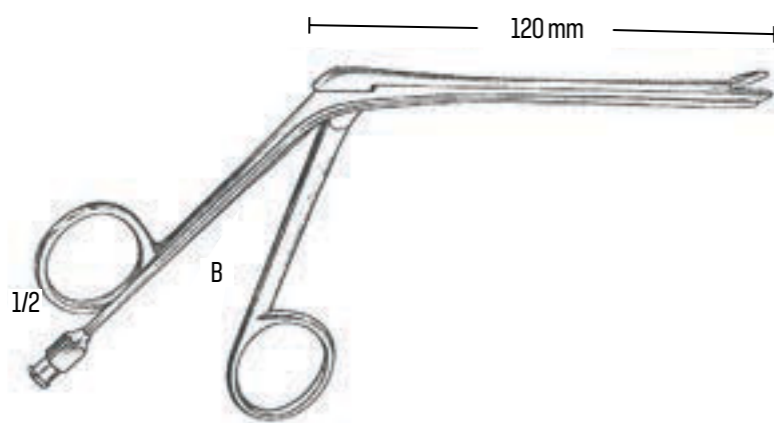
Fig. 3  
TI-23-882-03



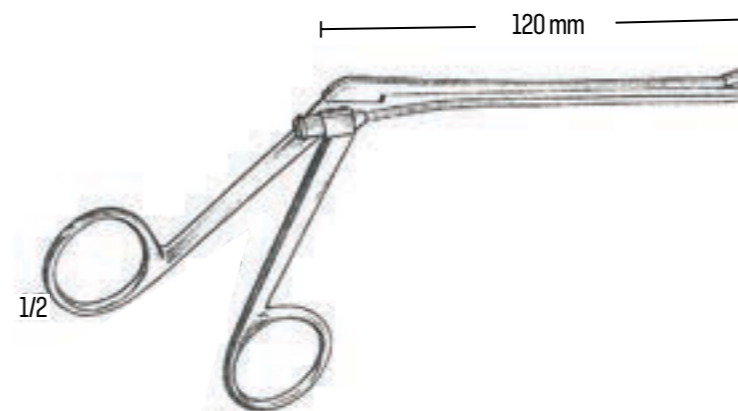


Weil - Blakesley  
 TI-23-930-01 - TI-23-930-23

		1/1		
0°	A	TI-23-930-01	TI-23-930-02	TI-23-930-03
	B	TI-23-930-11	TI-23-930-12	TI-23-930-13
45°	A	TI-23-930-06	TI-23-930-07	TI-23-930-08
	B	TI-23-930-16	TI-23-930-17	TI-23-930-18
90°	A	TI-23-930-21	TI-23-930-22	TI-23-930-23
	B	TI-23-930-31	TI-23-930-32	TI-23-930-33
		2.5 mm	3.0 mm	3.5 mm

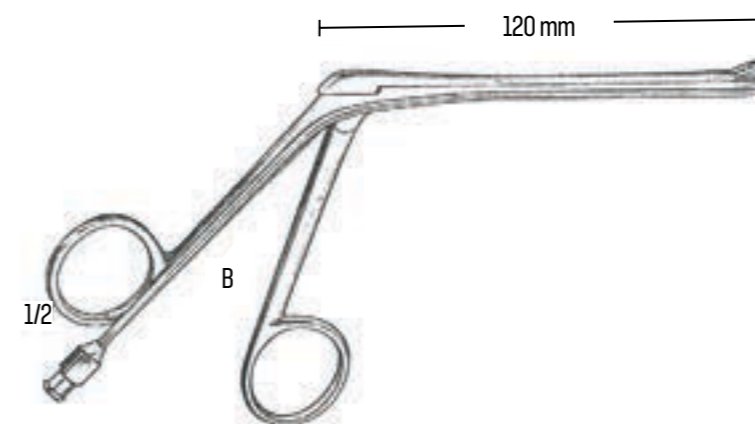


Weil - Blakesley  
 TI-23-930-11 - TI-23-930-33



Weil - Blakesley  
 TI-23-930-40 - TI-23-930-47

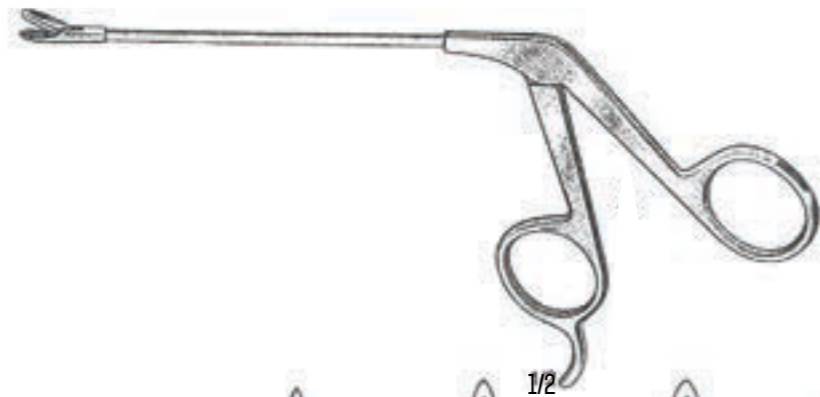
		1/1		
right	A	TI-23-930-40	TI-23-930-41	TI-23-930-42
	B	TI-23-930-50	TI-23-930-51	TI-23-930-52
left	A	TI-23-930-45	TI-23-930-46	TI-23-930-47
	B	TI-23-930-55	TI-23-930-56	TI-23-930-57
		2.5 mm	3.0 mm	3.5 mm



Weil - Blakesley  
 TI-23-930-50 - TI-23-930-57



120 mm - Ø 3.5 mm



Weil - Blakesley	0°	A	TI-23-940-01	TI-23-940-02	TI-23-940-03	TI-23-940-04
		B	TI-23-940-11	TI-23-940-12	TI-23-940-13	TI-23-940-14

2.5 mm      3.0 mm      3.5 mm      4.0 mm

Weil - Blakesley	45°	A	TI-23-940-06	TI-23-940-07	TI-23-940-08	TI-23-940-09
		B	TI-23-940-16	TI-23-940-17	TI-23-940-18	TI-23-940-19

2.5 mm      3.0 mm      3.5 mm      4.0 mm



Takahashi  
A TI-23-940-27  
B TI-23-940-37

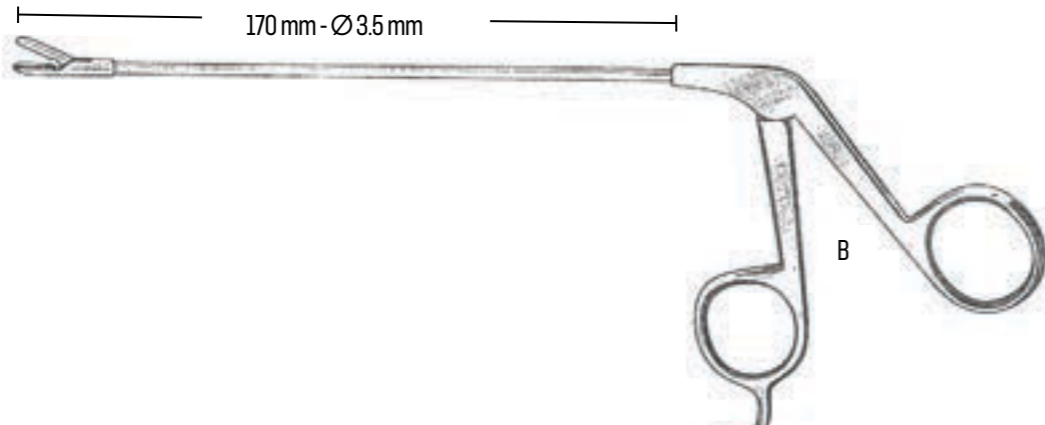
4 x 10 mm



Struycken  
A TI-23-940-28  
B TI-23-940-38

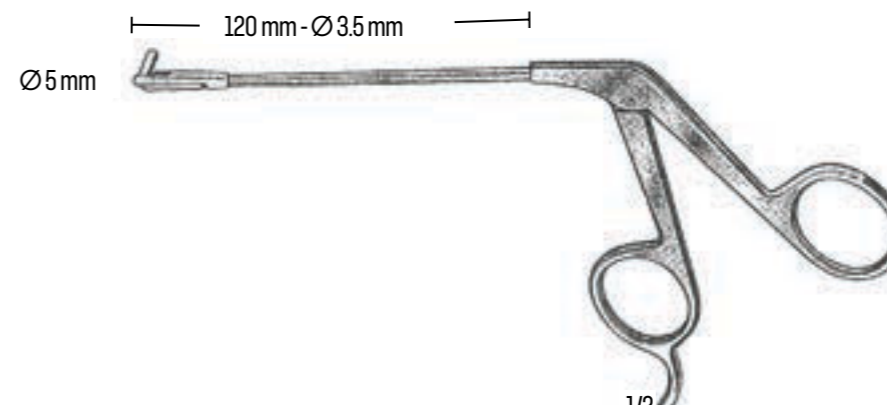
1 x 10 mm

170 mm - Ø 3.5 mm



1/2

120 mm - Ø 3.5 mm  
Ø 5 mm



1/2

Stanzen Punches  
TI-23-930-01 - TI-23-950-23

TI-23-950-01      TI-23-950-02      TI-23-950-03

TI-23-950-11      TI-23-950-12      TI-23-950-13

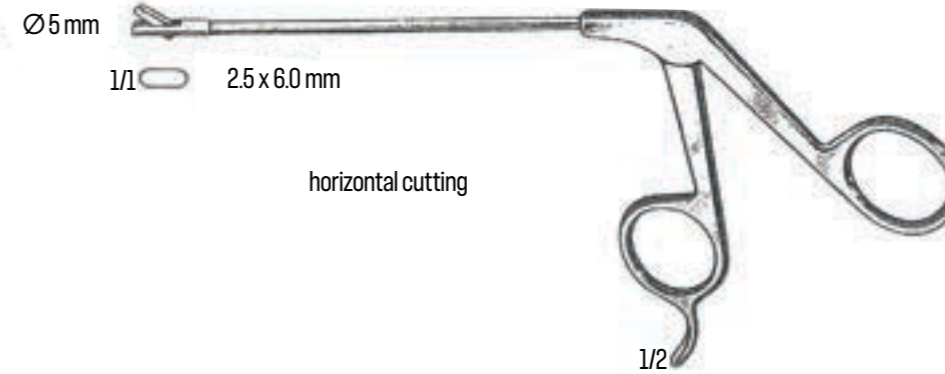
TI-23-950-21      TI-23-950-22      TI-23-950-23  
1.5 X 6.0 mm      2.0 X 6.0 mm      2.5 X 8.0 mm

120 mm - Ø 3.5 mm

Ø 5 mm

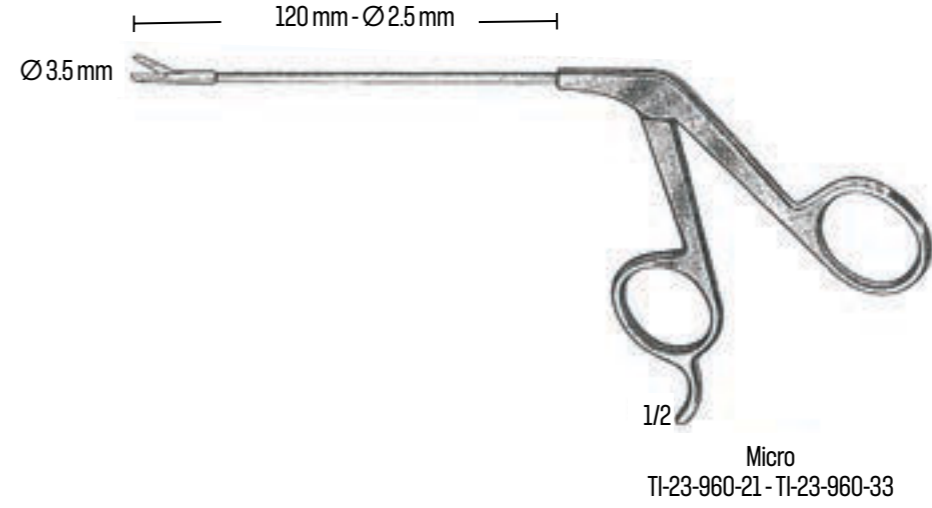
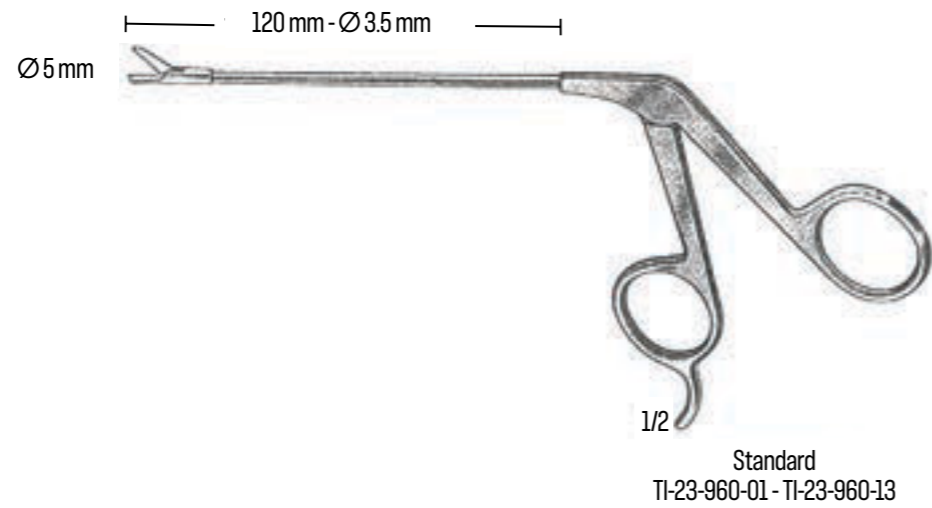
1/1 2.5 x 6.0 mm

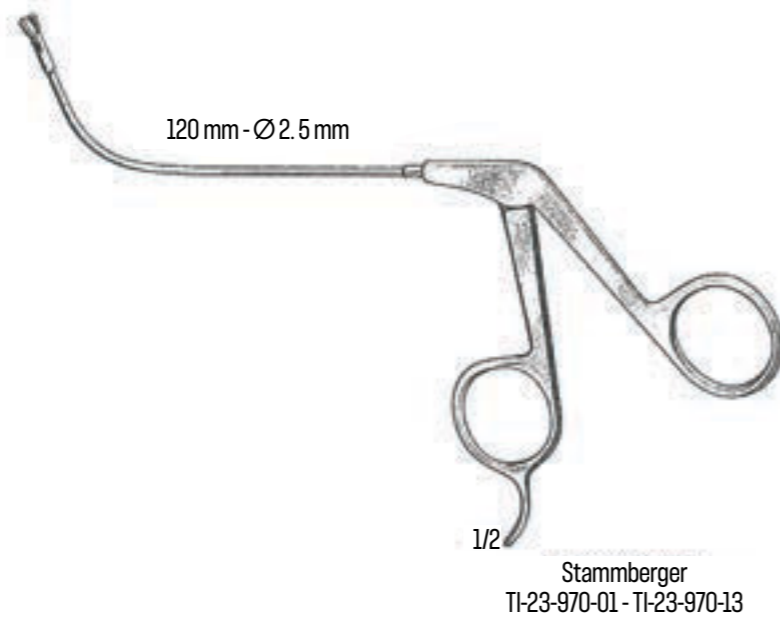
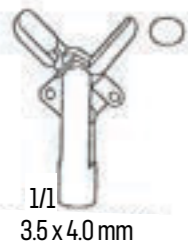
horizontal cutting



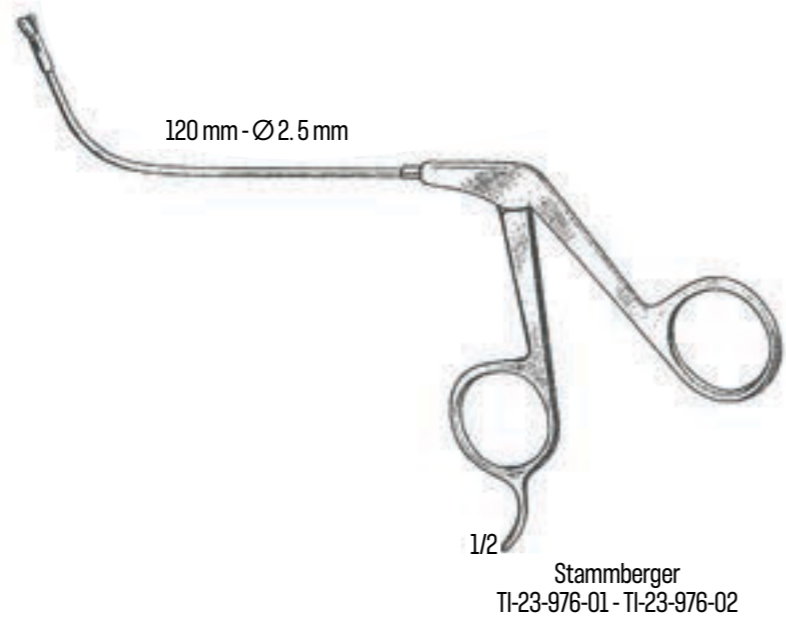
1/2

TI-23-956-01	0°
TI-23-956-02	30°
TI-23-956-03	45°
TI-23-956-04	60°
TI-23-956-05	70°





	horizontal cutting	vertical cutting
70°	TI-23-970-01	TI-23-970-11
90°	TI-23-970-02	TI-23-970-12
110°	TI-23-970-03	TI-23-970-13



	horizontal cutting	vertical cutting
65°	TI-23-970-01	TI-23-970-02



1/2  
 Heister  
 TI-24-100-13  
 13 cm



1/2  
 Molt  
 TI-24-141-11  
 11 cm



1/2  
 Molt  
 TI-24-141-14  
 14 cm



1/2  
 Denhart  
 TI-24-147-12  
 12 cm



Roser - Konig  
 TI-24-149-16 16 cm  
 TI-24-149-20 20 cm



1/2  
 Kilner - Doughty  
 TI-24-174-00  
 complete

TI-24-174-10  
 Gag only



1/2  
 Fig. 1  
 TI-24-174-01  
 65 x 28 mm



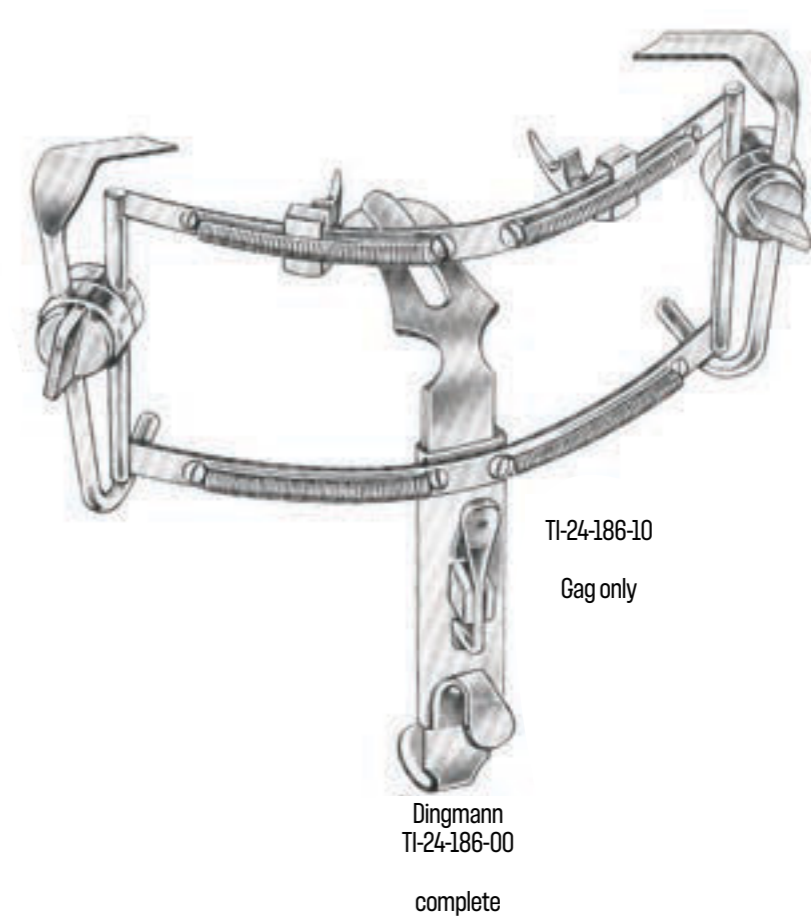
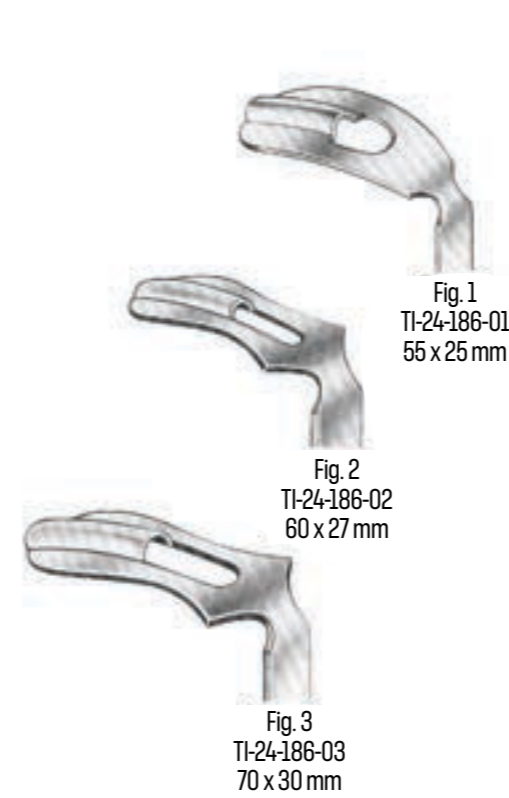
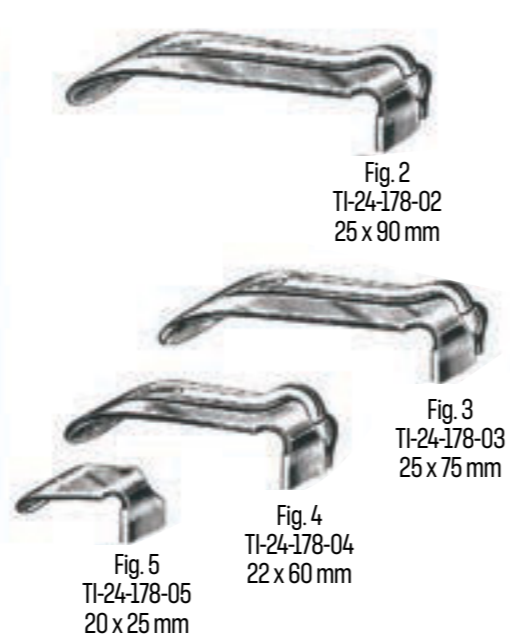
Fig. 2  
 TI-24-174-02  
 75 x 32 mm

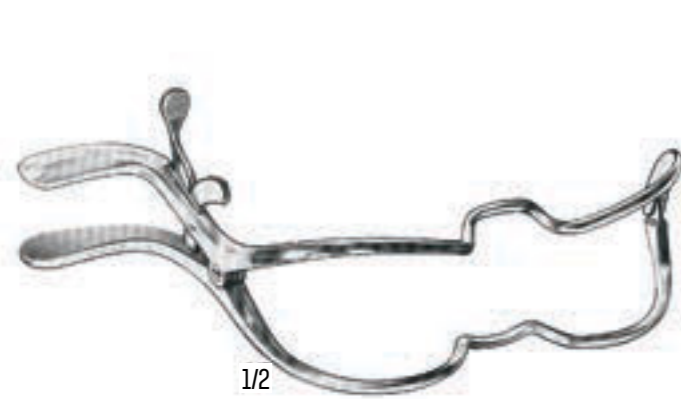


Fig. 3  
 TI-24-174-03  
 80 x 37 mm



TI-24-174-04





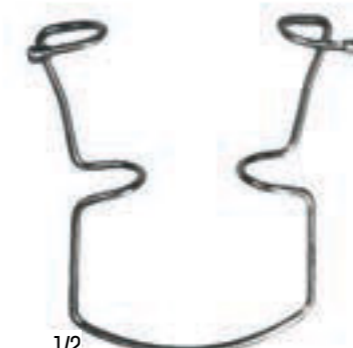
1/2

Jennings  
 TI-24-250-09  
 TI-24-250-11  
 TI-24-250-13  
 TI-24-250-15



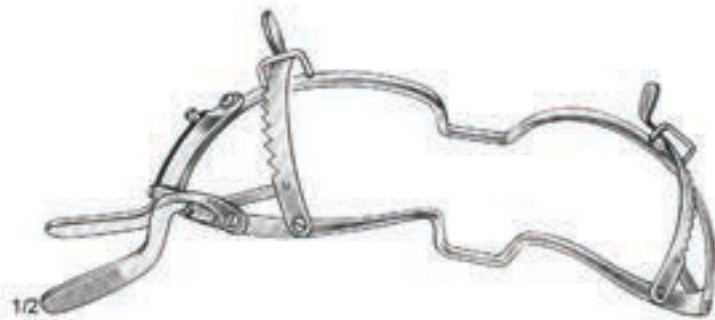
1/2

Seemann - Seiffert  
 TI-24-254-09  
 TI-24-254-11  
 TI-24-254-13  
 TI-24-254-15



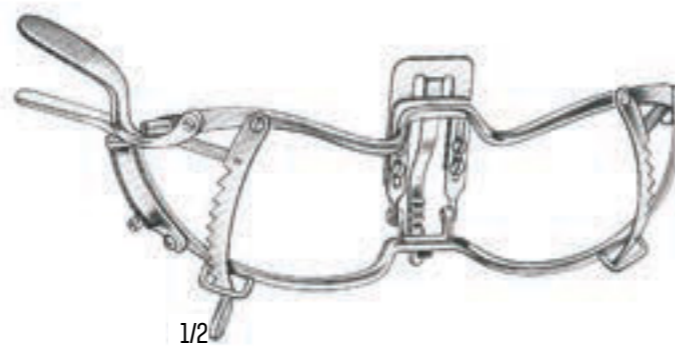
1/2

Oringer  
 TI-24-290-00 - TI24-290-13



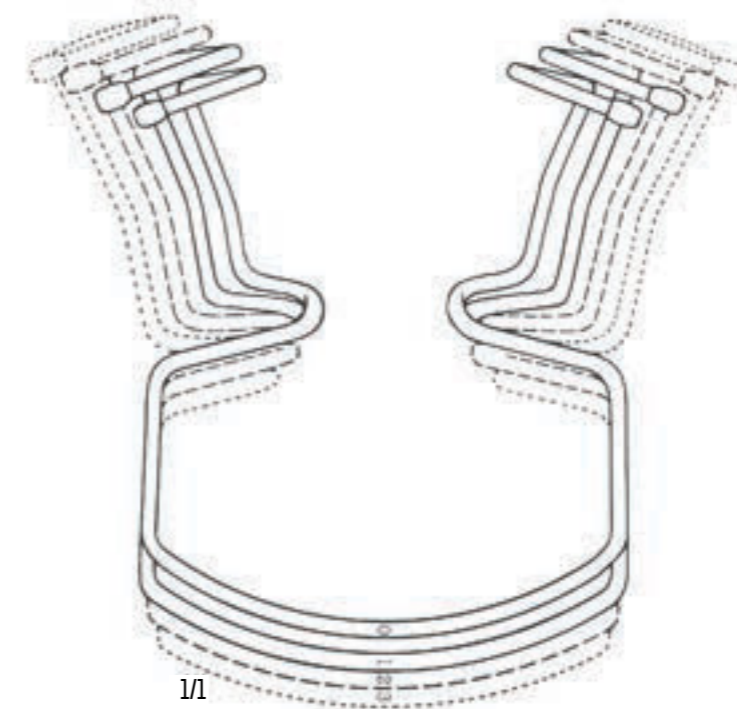
1/2

Whitehead  
 TI-24-260-09  
 TI-24-260-11  
 TI-24-260-13  
 TI-24-260-15



1/2

Whitehead  
 TI-24-264-09  
 TI-24-264-11  
 TI-24-264-13  
 TI-24-264-15



1/1

TI-24-290-00 Fig. 0 9.5 cm  
 TI-24-290-01 Fig. 1 10.0 cm  
 TI-24-290-02 Fig. 2 10.5 cm  
 TI-24-290-03 Fig. 3 11.0 cm

TI-24-290-13 Set (Fig.1 - 3)



1/2  
 Simplex  
 TI-24-301-11  
 11 cm



Stenberg  
 TI-24-305-12 12 cm  
 TI-24-305-14 14 cm  
 TI-24-305-16 16 cm



1/2  
 Hartmann  
 TI-24-321-15  
 15 cm



1/2  
 Tobold  
 TI-24-325-14  
 14.5 cm



1/2  
 Tobold  
 TI-24-329-14  
 14.5 cm



1/2  
 Mod. Martin  
 TI-24-309-19  
 19 cm



1/2  
 Mod. Martin  
 TI-24-311-21  
 21 cm



1/2  
 Bishop  
 TI-24-315-13  
 13 cm



1/2  
 Andrew  
 TI-24-333-11  
 11 cm



1/2  
 Wieder  
 TI-24-337-11 - TI-24-337-02



1/2  
 TI-24-337-01  
 14 cm



1/2  
 TI-24-337-02  
 15 cm



1/2  
Moritz - Schmidt  
TI-24-361-19  
19 cm



1/2  
Standard  
TI-24-365-14  
14.5 cm



1/2  
Univ. Minnesota  
TI-24-369-14



1/2  
Wood  
TI-24-381-16  
16 cm



1/2  
Plastic  
TI-24-365-15  
15 cm



1/2  
Haas  
TI-24-389-16  
16 cm



1/2  
Kroenig  
TI-24-371-15  
15 cm



1/2  
Mayo  
TI-24-375-17  
17 cm



1/2  
TI-24-379-18  
18 cm  
18 mm



1/2  
Buchwald  
TI-24-391-17  
17 cm



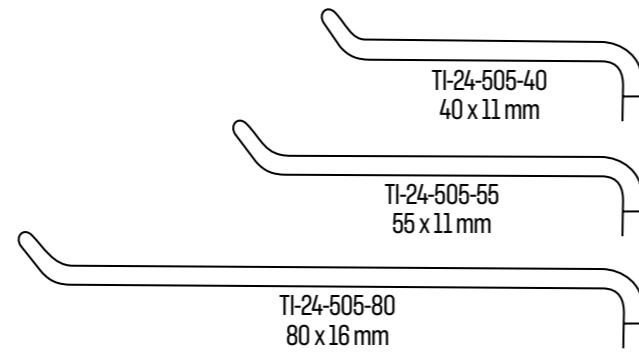
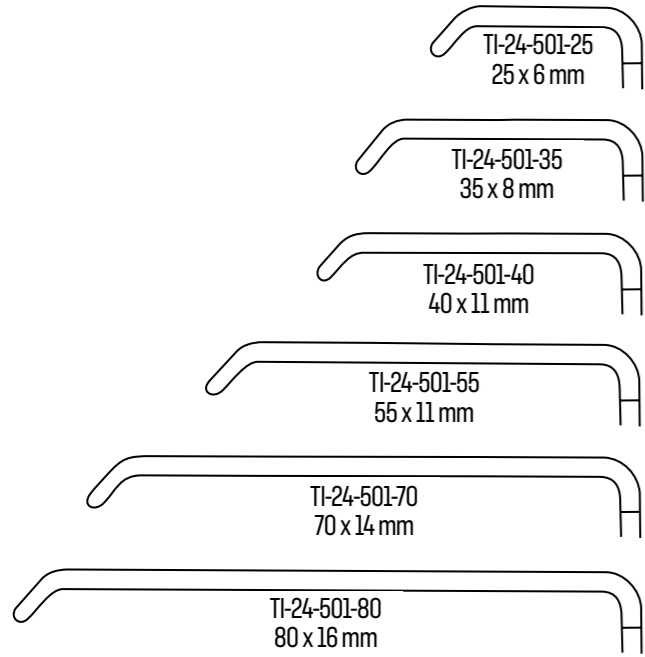
1/2  
Bruenings  
TI-24-395-19  
19 cm  
15 mm



1/2  
Frenzel  
TI-24-399-16  
16.5 cm



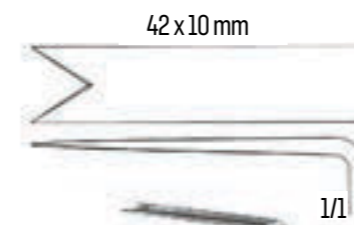




1/2  
Obwegeser  
TI-24-501-25 - TI-24-501-80  
21.5 cm



1/2  
Obwegeser  
TI-24-505-40 - TI-24-505-80  
22 cm





1/2  
 Obwegeser  
 TI-24-541-16  
 16 cm



1/2  
 Obwegeser  
 TI-24-545-08 8 mm  
 TI-24-545-08 10 mm  
 16 cm



1/2  
 Obwegeser  
 TI-24-560-06 - TI-24-560-11  
 17.5 cm



1/1  
 TI-24-560-06  
 6 mm



TI-24-560-07  
 7 mm



TI-24-560-09  
 9 mm



TI-24-560-11  
 11 mm



1/2  
 Obwegeser  
 TI-24-565-05 - TI-24-565-09  
 20 cm



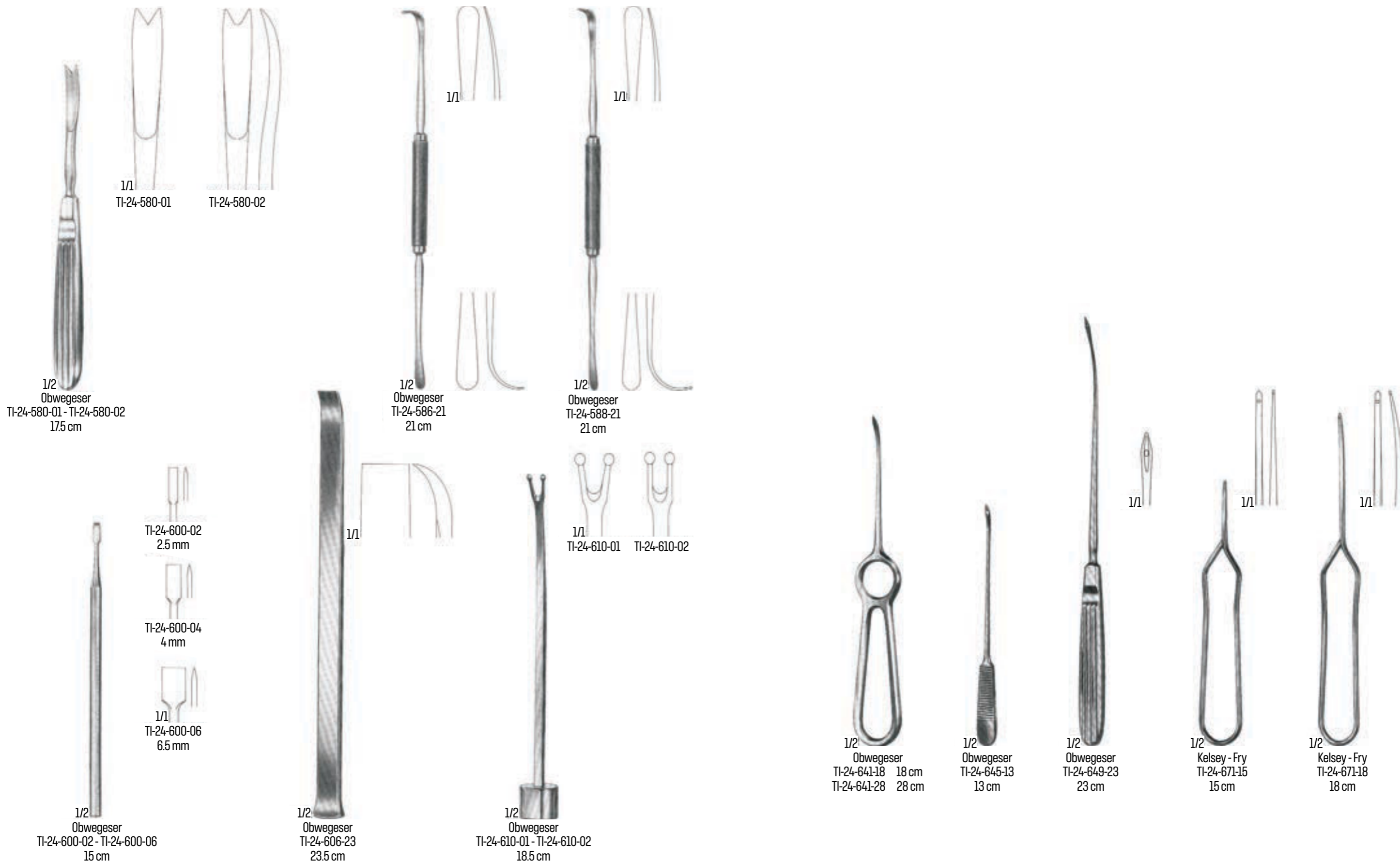
1/1  
 TI-24-565-05  
 5 mm



TI-24-565-07  
 7 mm



TI-24-565-09  
 9 mm

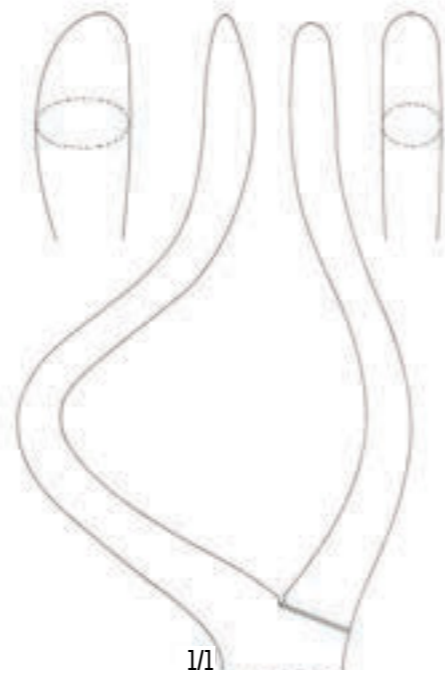




1/1  
 TI-24-750-01  
 TI-24-754-01



1/1  
 TI-24-750-02  
 TI-24-754-02



1/1  
 TI-24-750-03  
 TI-24-754-03



Rowe  
 TI-24-750-01 - TI-24-750-03



right  
 Rowe  
 TI-24-754-01 - TI-24-754-03

curved to left  
for the right hand



curved to right  
for the left hand



1/2  
Hurd  
TI-25-103-21 - TI-25-107-21  
21 cm

curved to left  
for the right hand



curved to right  
for the left hand



1/2  
Dupuy Weiss  
TI-25-113-22 - TI-25-117-22  
22 cm



1/2  
Roder  
TI-25-131-26  
26.5 cm



1/2  
Abraham  
TI-25-151-19  
19 cm



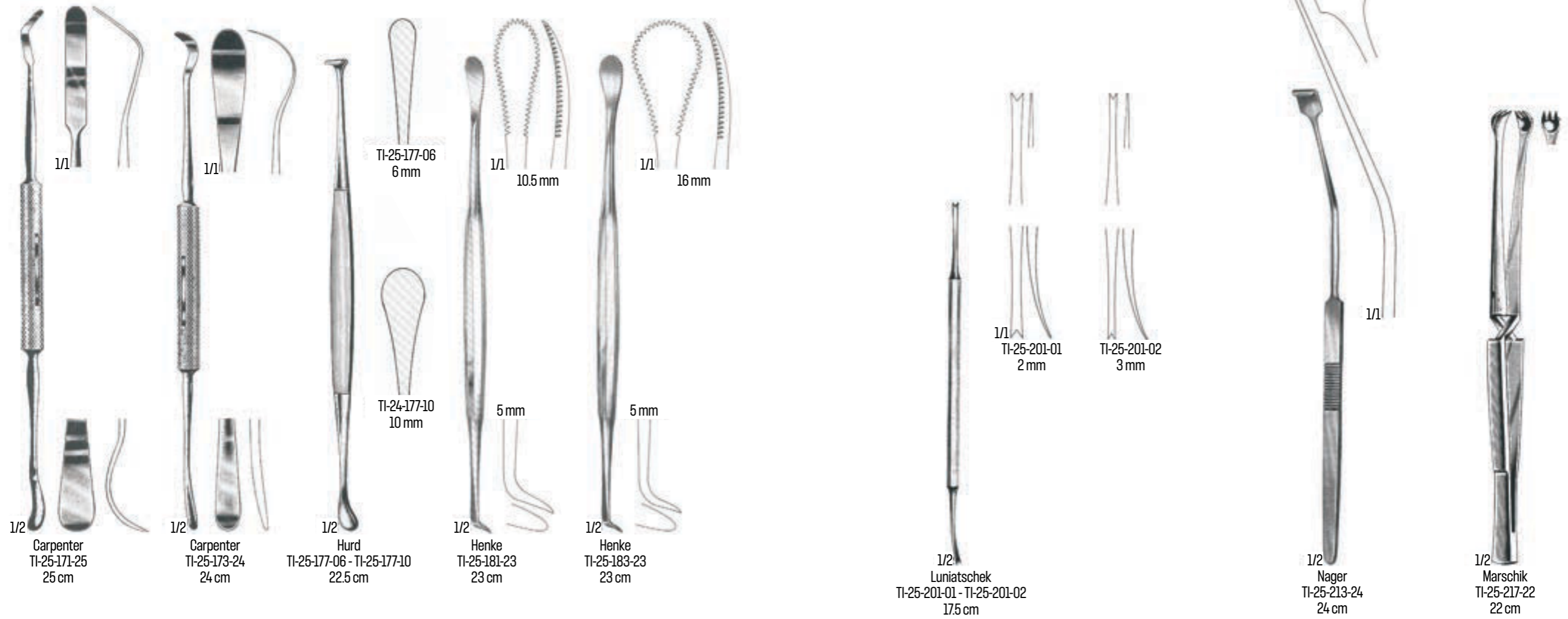
1/2  
Canfield  
TI-25-153-21  
21 cm

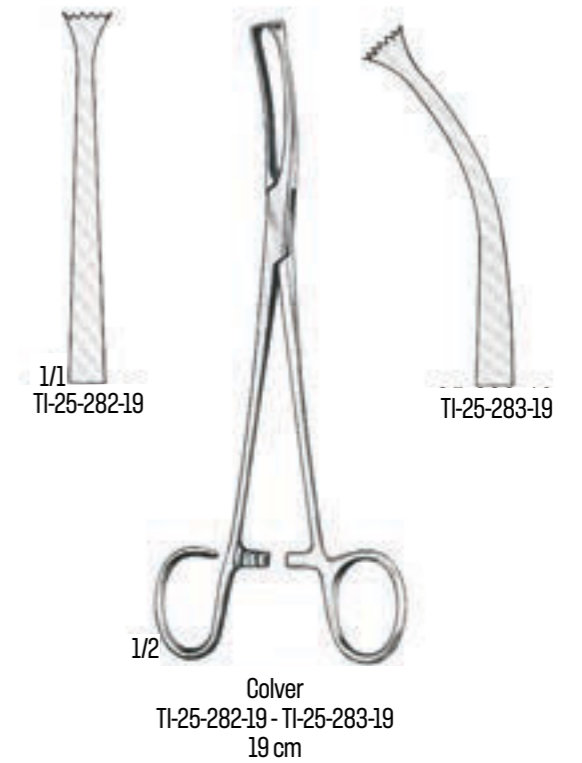


1/2  
Douglas  
TI-25-157-21  
21 cm

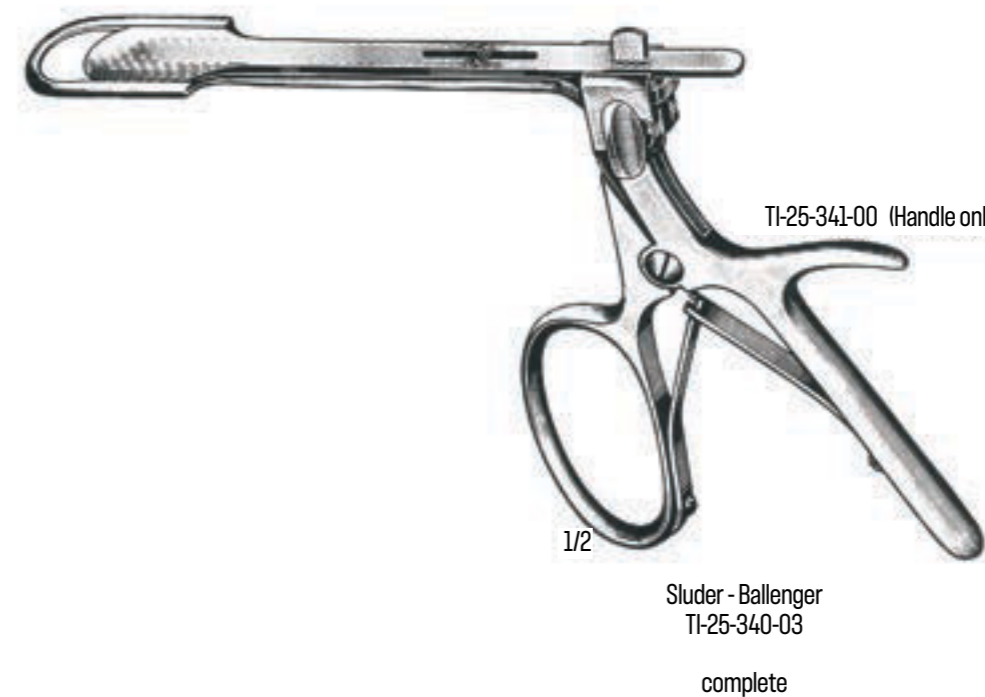
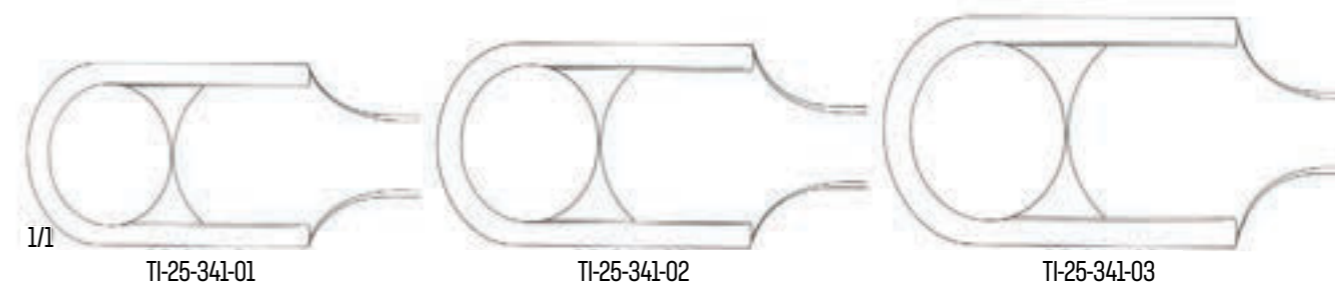
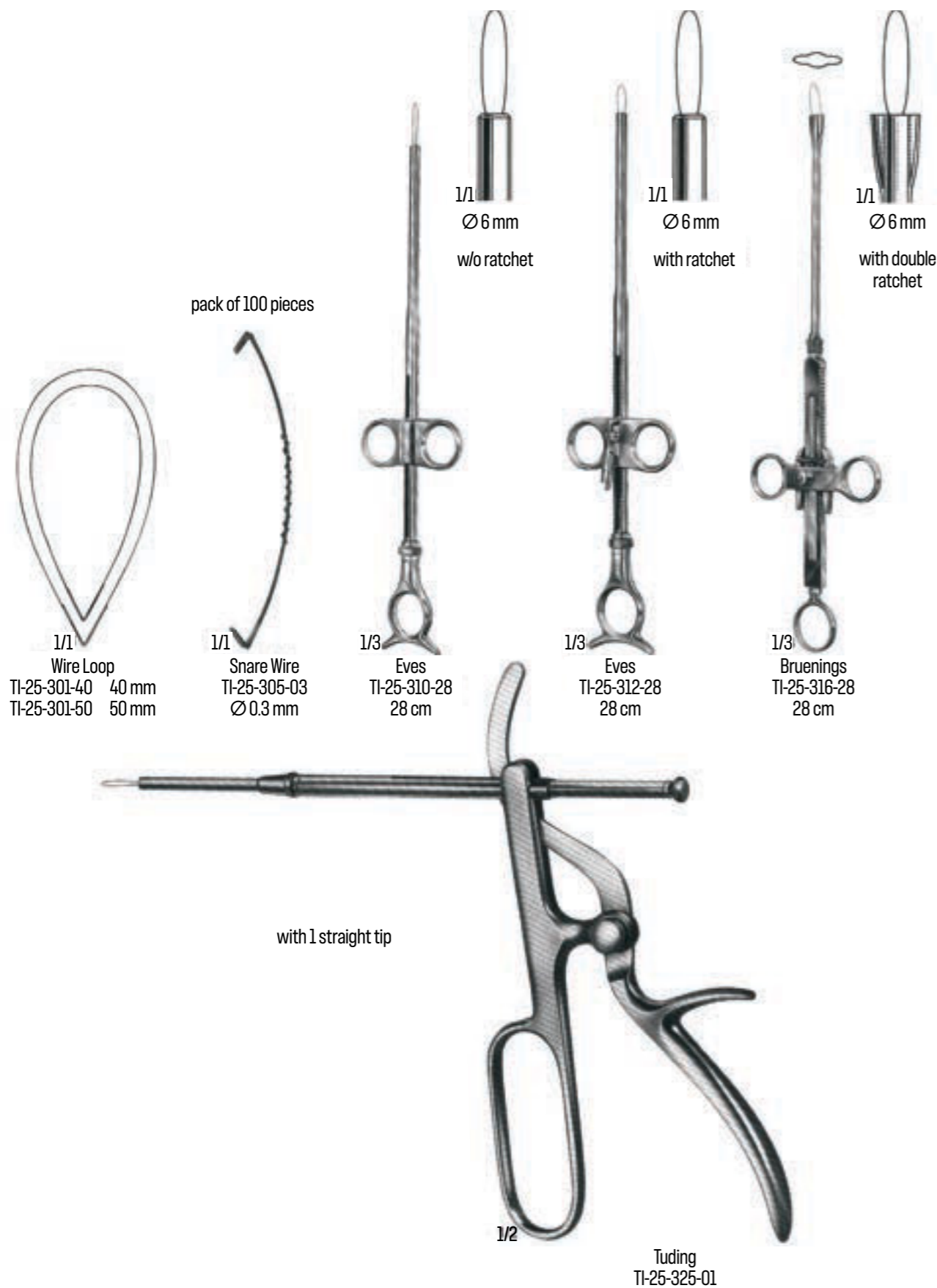


1/2  
Fisher  
TI-25-159-22  
22.5 cm











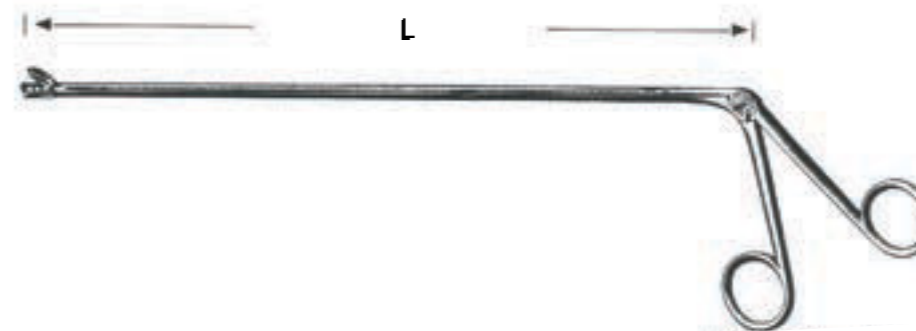
Hartmann  
 TI-25-351-13 - TI-25-351-17



Corwin  
 TI-25-361-14  
 14 cm



Vetter - Ulrich  
 TI-25-365-15



Chevalier - Jackson  
 TI-25-500-30 - TI-25-520-60



L- 30 cm  
 L- 40 cm  
 L- 50 cm  
 L- 60 cm

TI-25-500-30  
 TI-25-500-40  
 TI-25-500-50  
 TI-25-500-60

TI-25-502-30  
 TI-25-502-40  
 TI-25-502-50  
 TI-25-502-60

TI-25-504-30  
 TI-25-504-40  
 TI-25-504-50  
 TI-25-504-60

TI-25-506-30  
 TI-25-506-40  
 TI-25-506-50  
 TI-25-506-60



L- 30 cm  
 L- 40 cm  
 L- 50 cm  
 L- 60 cm

TI-25-508-30  
 TI-25-508-40  
 TI-25-508-50  
 TI-25-508-60

TI-25-510-30  
 TI-25-510-40  
 TI-25-510-50  
 TI-25-510-60

TI-25-512-30  
 TI-25-512-40  
 TI-25-512-50  
 TI-25-512-60

TI-25-514-30  
 TI-25-514-40  
 TI-25-514-50  
 TI-25-514-60



L- 30 cm  
 L- 40 cm  
 L- 50 cm  
 L- 60 cm

TI-25-516-30  
 TI-25-516-40  
 TI-25-516-50  
 TI-25-516-60

TI-25-518-30  
 TI-25-518-40  
 TI-25-518-50  
 TI-25-518-60

TI-25-520-30  
 TI-25-520-40  
 TI-25-520-50  
 TI-25-520-60



Huber  
TI-25-531-01



Bruenings  
TI-25-531-01



TI-25-534-20 20 cm  
 TI-25-534-30 30 cm  
 TI-25-534-40 40 cm



Bruenings  
TI-25-537-20  
20 cm



Fraenkel  
TI-25-550-01



Seiffert  
TI-25-552-01



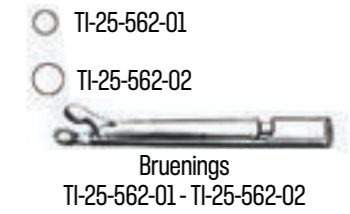
Fraenkel  
TI-25-554-01



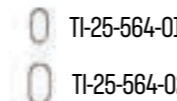
Scheinmann  
TI-25-557-01



Scheinmann  
TI-25-559-01



Bruenings  
TI-25-562-01 - TI-25-562-02



TI-25-564-01  
 TI-25-564-02



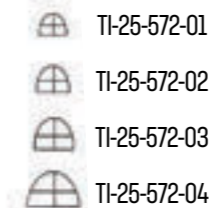
Bruenings  
TI-25-564-01 - TI-25-564-02



Lange  
TI-25-566-01



Krause  
TI-25-568-01 - TI-25-568-02



TI-25-572-01  
 TI-25-572-02  
 TI-25-572-03  
 TI-25-572-04



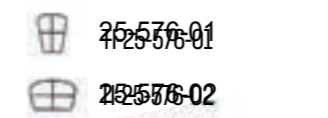
Krause  
TI-25-570-01



Cordes  
TI-25-572-01 - TI-25-572-02



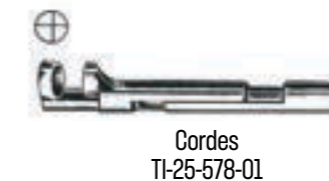
Schumacher  
TI-25-574-01



TI-25-576-01  
 TI-25-576-02



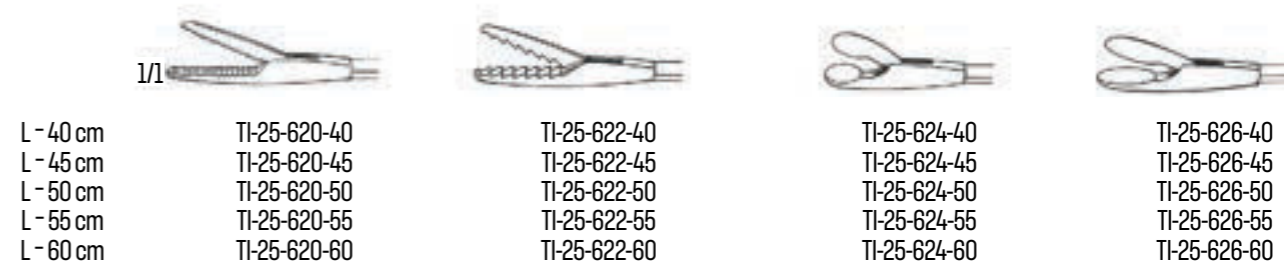
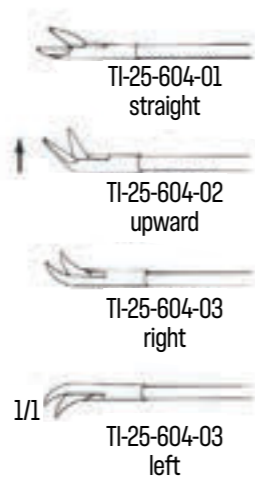
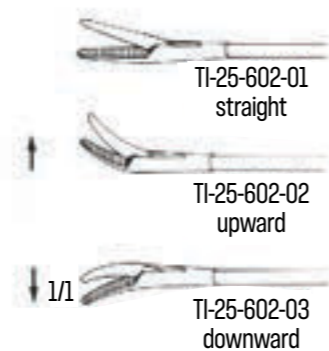
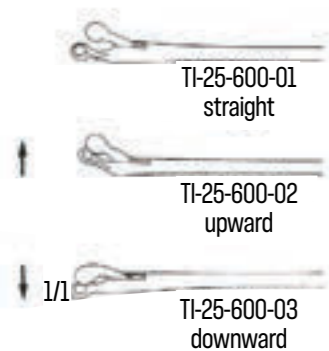
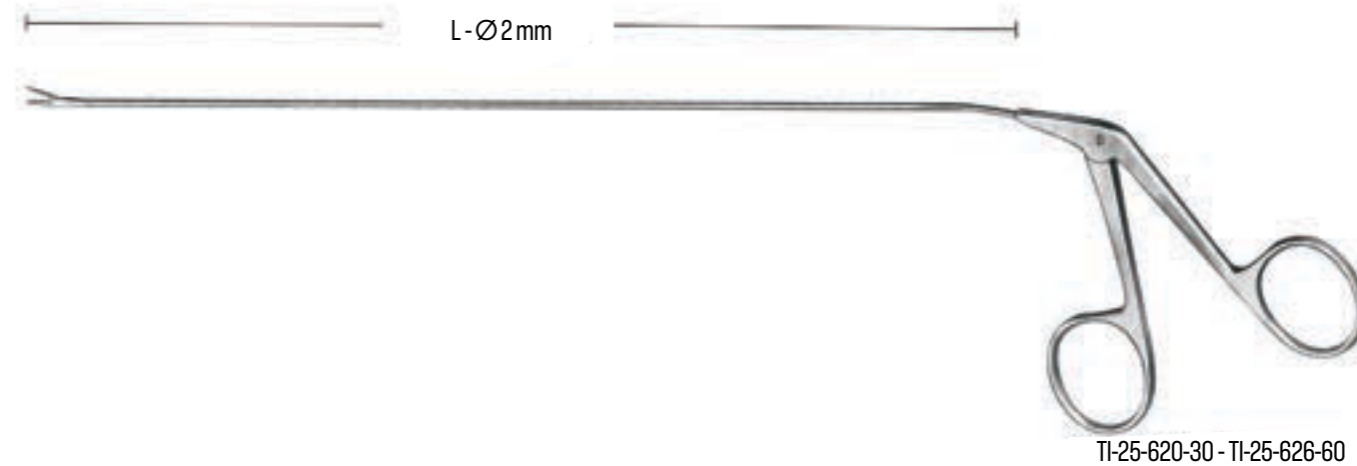
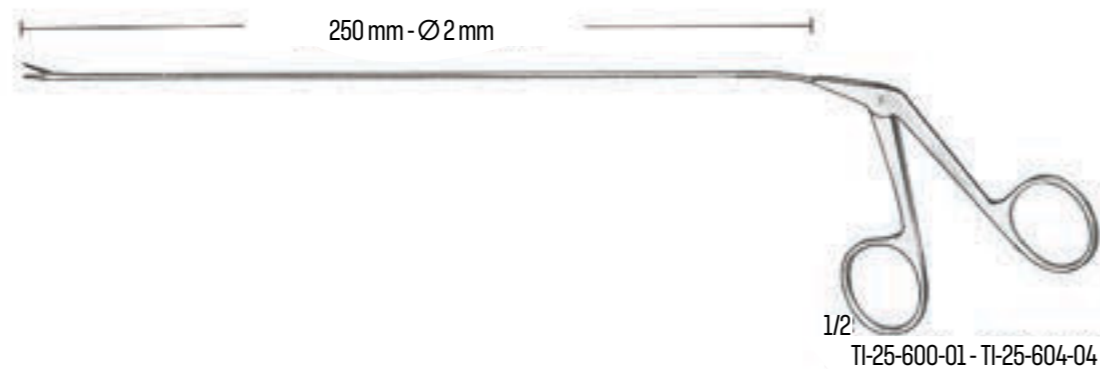
Cordes  
TI-25-576-01 - TI-25-576-02

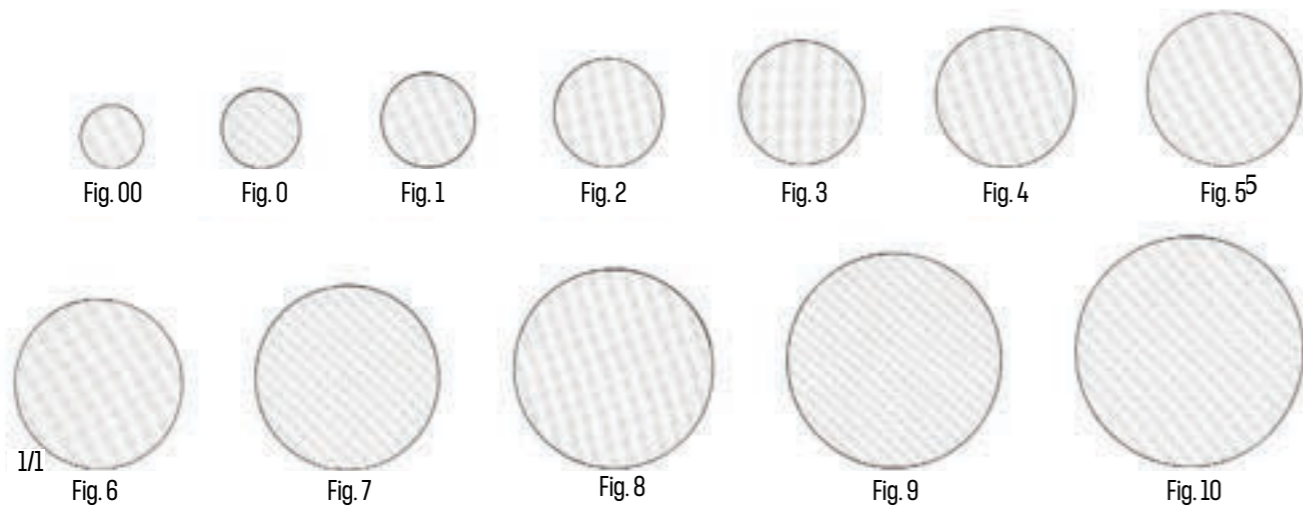


Cordes  
TI-25-578-01



Rosenberg  
TI-25-580-01





plane, with fixed handle



plane, without handle



Fig.	Ø mm	TI-25-650-08	TI-25-654-08
00	8	TI-25-650-08	TI-25-654-08
0	10	TI-25-650-10	TI-25-654-10
1	12	TI-25-650-12	TI-25-654-12
2	14	TI-25-650-14	TI-25-654-14
3	16	TI-25-650-16	TI-25-654-16
4	18	TI-25-650-18	TI-25-654-18
5	20	TI-25-650-20	TI-25-654-20
6	22	TI-25-650-22	TI-25-654-22
7	24	TI-25-650-24	TI-25-654-24
8	26	TI-25-650-26	TI-25-654-26
9	28	TI-25-650-28	TI-25-654-28
10	30	TI-25-650-30	TI-25-654-30



1/2  
Michel  
TI-25-661-12 - TI-25-661-18  
25 mm



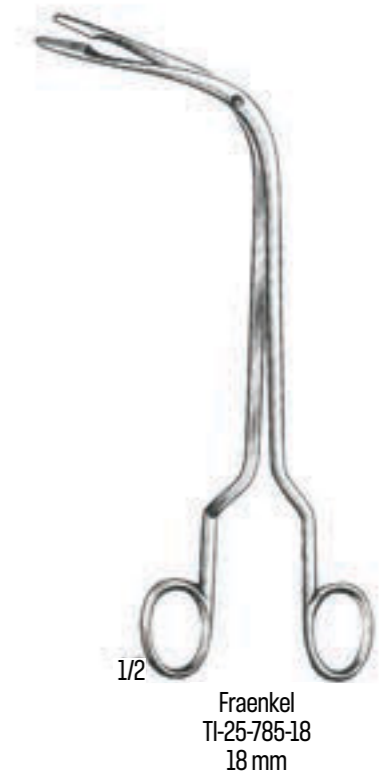
1/2  
TI-25-664-10  
10 cm



1/2  
TI-25-666-11  
11 cm



1/2  
TI-25-668-12  
12.5 cm



## Index

<b>A</b>	
Abraham Knife	25-3
Adenoid Curettes	23-46—23-48
Adenotomes	23-48
Andrew Tongue Depressor	24-9
Antrum Punch Forceps	23-17—23-19
Antrum Rasps	23-33
Asch Septum Forcep	23-44
Aufricht Glabella Rasp	23-33
Aufricht Nasal Retractor	23-40, 23-42
Awis	24-19
<b>B</b>	
Ballenger Septal Knife	23-21
Ballenger Septum Gouge	23-27
Barbara Ear Needle	22-10—22-11
Barnhill Adenoid Curette	23-47
Baron (Schuknecht) Suction Tube	22-17
Barth Ear Spoon	22-33
Beckmann Adenoid Curette	23-46
Beckmann Nasal Speculum	23-3, 23-6
Belluci Micro Ear Scissor	22-5
Beyer Ear Punch	22-31
Billeau Ear Loop	22-34
Bishop Tongue Depressor	24-8
Blohmke Tonsil Seizing Forcep	25-7
Boies Rhinoplastic Instrument	23-16
Bone Files	23-33
Boucheron Ear Speculum	22-19
Broncho-Esophagoscopy Forceps	25-11
Bruenings Cutting Forcep Tip	25-13
Bruenings Septal Knife	23-21
Bruenings Septum Compression Forcep	23-10
Bruenings Tongue Depressor	24-11
Bruenings Tonsil Snare	25-8
Bruenings Universal Handle	25-12
Buchwald Tongue Depressor	24-11
Buck Ear Curette	22-32—22-33
Buck Foreign Body Lever	22-29
Buck Paracentesis Needle	22-36
Buckingham Foot Plate Instrument	22-13
<b>C</b>	
Canfield Knife	25-3
Caplan Septum Scissor	23-15
Carpenter Tonsil Knife	25-4
Cawfood Retractor	24-12
Cheek-Lip Retractors	24-7—24-9
Chevalier-Jackson Broncho-Esophagoscopy Forcep	25-11
Chin Retractors and Channelled Retractors	24-16
Chisel Maxillo-Facial Surgery	24-18
Chisels	23-29, 23-31
Cinelli Chisel	23-29
Citelli Ear Punch	22-31
Cleft Plate Needles	25-2
Coakley Curette	23-45
Collin Tongue Holding Forcep	24-13
Colver Tonsil Seizing Forcep	25-7
Converse Chisel	23-31
Converse Mucosa Hooklet	23-40
Converse Nasal Rasp	23-35
Converse Rhinoplastic and Nasal Knife	23-20
Cordes Cutting Forcep Tip	25-13
Corwin Tonsil Hemostats	25-10
Cottle (Collumella) Skin Grasping Forcep	23-43
Cottle Cartilage Crusher	23-32
Cottle Guide Support for Osteotomes	23-32
Cottle Handle	23-32
Cottle Mucosa Hooklet	23-40—23-41
Cottle Nasal Rasp	23-33
Cottle Nasal Retractor	23-42
Cottle Nasal Speculum	23-4—23-5
Cottle Osteotome	23-28
Cottle Rhinoplastic and Nasal Knife	23-20
Cottle Septum and Periosteal Elevator	23-24—23-25
Cottle Skin Grasping Forcep	23-43
Cottle-Neivert Alar Hooklet	23-41
Cottle-TC Nasal Rasp	23-39
Cottle-Walsham Septum Forcep	23-44
Crura and Malleus Nipper	22-7
Curette-Ear	22-12, 22-32—22-33, 22-38
Curettes-Rhinology	23-45
Cutting and Grasping Forceps Tips	25-13
<b>D</b>	
Davis-Boyle Mouth Gag	24-4
Day Ear Hook	22-35
Denhart Mouth Gag	24-2
Dingmann Mouth Gag	24-5
Disimpaction Forceps	24-20
Dissectors	25-4, 25-6
Dissectors-Ear	22-12
Douglas Knife	25-3
Duplay Nasal Speculum	23-2
Dupuy Weiss Tonsil Needle	25-2
<b>E</b>	
Ear Dressing Forceps	22-28
Ear Polypus Forcep	22-29—22-30
Ear Polypus Snares	22-27
Ear Punches	22-31
Ear Specula	22-18—22-20
Ear Specula Holder	22-20
Ear Syringe	22-40
Eicken Killian Irrigation Cannula	23-49
Elevators-Ear	22-12, 22-38—22-39
Endolaryngeal Micro Surgery Forcep	25-14
Enucleators	25-4
Epiglottis Retractors	25-18
Eustachian Catheters	22-27
Eves Tonsil Snare	25-8
<b>F</b>	
Farrion Ear Speculum	22-19
Faulkner Curette	23-45
Ferris Smith Kerrison Antrum Punch Forcep	23-19
Ferris-Smith-Kerrison (Cloward Harper) Antrum Punch Forcep	23-18
Fisch Elevator	22-12
Fisher Tonsil Knife	25-3
Fomon Alar Hooklet	23-41
Fomon Chisel	23-29
Fomon Mucosa Hooklet	23-40
Fomon Nasal Rasp	23-34
Fomon Rhinoplastic and Nasal Knife	23-20
Fomon-TC Nasal Rasp	23-38

## Index

Foot Plate Hand Instruments	22-13	Hurd Cleft Plate Needle	25-2
Foot Plate Instruments acc to Heermann	22-14	Hurd Tonsil Dissector	25-4
Forceps for Laryngo Bronchoscopy	25-15	<b>J</b>	
Foreign Body Instruments	22-34	Jansen Ear Dressing Forcep	22-28
Foreign Body Levers	22-29	Jansen Ear Spoon	22-33
Fraenkel Grasping Forcep Tip	25-13	Jansen-Middleton Septum Compression Forcep	23-14
Fraenkel Laryngeal Polypus Forcep	25-19	Jennings Mouth Gag	24-6
Freer Mucosa Hooklet	23-40	Joseph Bone File	23-33
Freer Rhinoplastic and Nasal Knife	23-22	Joseph Mucosa Hooklet	23-40—23-41
Freer Septal Knife	23-21	Joseph Nasal Saw	23-30
Freer Septum Chisel	23-26	Joseph Rhinoplastic and Nasal Knife	23-20, 23-22
Freer Septum Elevator	23-23	Joseph Septum and Periosteal Elevator	23-25
Freer Septum Gouge	23-26	Joseph Septum Elevator	23-23
French Tuning Fork	22-21	Joseph-Masing Septum and Periosteal Elevator	23-25
Frenzel Tongue Depressor	24-11	Juers Wire Closure Forcep	22-6
Fuller Crura and Malleus Nipper	22-7	Jurasz Laryngeal Polypus Forcep	25-18
<b>G</b>			
Gallaher Antrum Rasp	23-33	<b>K</b>	
Gerzog-Sexton Paracentesis Needle	22-36	Kelsey-Fry Awis	24-19
Glabella Rasps	23-33	Kerrison Antrum Punch Forcep	23-19
Goldmann Rhinoplastic Instrument	23-16	Killian Nasal Polypus Forcep	23-9
Goldsmith Nasal Speculum	23-2	Killian Nasal Speculum	23-3
Graig Septum Compression Forcep	23-10	Killian Septum and Periosteal Elevator	23-24
Graig-Domnick Septum Compression Forcep	23-10	Killian Septum Gouge	23-26
Greven Wire Closure Forcep	22-6	Killian Septum Scissor	23-15
Gross Ear Hook	22-34	Killian-Claus Septum Gouge	23-26
Gruber Ear Speculum	22-18	Kilner Mucosa Hooklet	23-40
Gruenwald (Jansen) Nasal Dressing Forcep	23-8	Kilner-Doughty Mouth Gag	24-3
Gruenwald Nasal Cutting Forcep	23-13	Knight Septum Compression Forcep	23-9
Guilen Irrigation Cannula	23-49	Koenig Tuning Fork	22-26
<b>H</b>			
Hajak Nasal Cutting Forcep	23-13	Krause Cutting Forcep Tip	25-13
Hajak-Claus Antrum Punch Forcep	23-19	Krause Nasal Snare	23-7
Hajak-Koffler Antrum Punch Forcep	23-17	Krause Polypus Snare	22-27
Halle Septum Elevator	23-23	Krause-Voss Nasal Snare	23-7
Handle for Laryngeal Mirrors	25-17	Krause-Voss Polypus Snare	22-27
Hartmann Ear Hook	22-34	Kressner Rhinoplastic Instrument	23-16
Hartmann Ear Polypus Forcep	22-29—22-30	Kroenig Tongue Depressor	24-10
Hartmann Ear Speculum	22-18	<b>L</b>	
Hartmann Eustachian Catheter	22-27	La Force Adenotome	23-48
Hartmann Nasal Cutting Forcep	23-13	Lange Grasping Forcep Tip	25-13
Hartmann Nasal Polypus Forcep	23-8—23-9	Lange Laryngeal Polypus Forcep	25-19
Hartmann Nasal Speculum	23-6	Lange Mucosa Hooklet	23-40
Hartmann Tongue Depressor	24-9	Langenbeck Ear Curette	22-32
Hartmann Tonsil Punch Forcep	25-10	Lange-Wilde Nasal Snare	23-7
Hartmann Tuning Fork	22-21, 22-23, 22-25	Larkin Foot Plate Instrument	22-13
Hartmann-Halle Nasal Speculum	23-2	Laryngeal Mirrors	25-16—25-17
Hartmann-Hoffmann Ear Polypus Forcep	22-30	Laryngeal Polypus Forceps	25-18—25-19
Hartmann-Noyes Ear Polypus Forcep	22-30	Lempert Curette	22-38
Hartmann-Weingartner Ear Polypus Forcep	22-30	Lempert Elevator	22-38—22-39
Hartmann-Wullstein Ear Polypus Forcep	22-30	Lempert Raspatory	22-38
Haslinger Tonsil Retractor	25-6	Lewis Nasal Rasp	23-33
Hass Tongue Depressor	24-11	Lewis-TC Nasal Rasp	23-39
Heister Mouth Gag	24-2	Ligature Carriers	25-3
Henke Enucleators	25-4	Littauer Ear Polypus Forcep	22-29
Heymann Septum Compression Forcep	23-9	Littauer Nasal Polypus Forcep	23-9
Heymann-Knight Nasal Polypus Forcep	23-8	Loops-Ear	22-34—22-35
Hofer Tonsil Retractor	25-6	Lopez-Reinke Tonsil Dissector	25-6
Hooklets-Ear	22-15, 22-35	Love Tonsil Retractor	25-6
Hooks-Ear	22-34	Lubet-Barbon Nasal Polypus Forcep	23-8
House Dissector	22-12	Luc Septum Compression Forcep	23-10
House Foot Plate Instrument	22-13		
House Suction Tube	22-17		
House-Dieter Crura and Malleus Nipper	22-7		
Huber Universal Handle	25-12		

## Index

Lucae Ear Dressing Forcep	22-28
Lucae Ear Hook	22-35
Lucae Paracentesis Needle	22-36
Lucae Tuning Fork	22-24—22-25
Luniatschek Tonsil Packer	25-5
<b>M</b>	
Maltz Nasal Rasp	23-33
Maltz Rhinoplastic and Nasal Knife	23-22
Maltz-T/C Nasal Rasp	23-37
Marschik Tonsil Forcep	25-5
Masing Chisel	23-31
Masing Nasal Rasp	23-35
Masing Rhinoplastic and Nasal Knife	23-20
Masing Septum and Periosteal Elevator	23-25
Mayo Tongue Depressor	24-10
Mc Ivor Mouth Gag	24-4
McGee Picks and Hooks	22-11
McGee Wire Closure Forcep	22-6
McKenty Septum and Periosteal Elevator	23-24
McKenty Septum Elevator	23-23
Michel Laryngeal Mirror	25-17
Micro Ear Forceps	22-2—22-4, 22-8
Micro Ear Knives	22-9
Micro Ear Scissors	22-5
Micro Sinuscopy Forcep	23-55
Miller-Colburn Nasal Rasp	23-36
Mini Mc Gee Alligator Forcep	22-2
Minnesota Retractor	24-12
Mobilizers-Ear	22-12
Mod. Martin Cheek-Lip Retractor	24-8
Mod. Wien Nasal Speculum	23-3
Modell Wurzburg Tongue Plate for Mouth Gag	24-5
Moldenhauer Foreign Body Instrument	22-34
Molt Mouth Gag	24-2
Moritz-Schmidt Tongue Depressor	24-10
Mouth Gags	24-2—24-6
Mucosa Hooklets	23-40—23-41
Museum Tonsil Seizing Forcep	25-7
Myles Nasal Cutting Forcep	23-13
<b>N</b>	
Nager Tonsil Retractor	25-5
Nasal Cutting Forcep	23-11—23-13
Nasal Dressing Forceps	23-8
Nasal Polypus Forcep	23-8—23-10
Nasal Rasps	23-34—23-39
Nasal Retractors	23-40, 23-42
Nasal Saws	23-30
Nasal Snares	23-7
Nasal Specula	23-2—23-6
Needles-Ear	22-10—22-11, 22-15—22-16
Negus Chest Support for Mouth Gag	24-5
Neivert Nasal Retractor	23-42
Neivert Osteotome	23-31
<b>O</b>	
Obwegeser Awis	24-19
Obwegeser Chin and Channelled Retractor	24-16
Obwegeser Chisel	24-18
Obwegeser Osteotome Maxillo-Facial	24-18

Surgery	
Obwegeser Periosteal Elevator	24-17—24-18
Obwegeser Ramus Retractor	24-15
Obwegeser Soft Tissue Retractor	24-14
Ogura Skin Grasping Forcep	23-43
Oringer Cheek-Lip Retractor	24-7
Osteotome Maxillo-Facial Surgery	24-18
Osteotomes	23-28—23-30, 23-31
<b>P</b>	
Paracentesis Knife	22-37
Paracentesis Needles	22-36—22-37
Pennington Septum and Periosteal Elevator	23-24
Periosteal Elevator	24-17—24-18
Picks and Hooks	22-10—22-11
Pierce Septum and Periosteal Elevator	23-24
Plester Ear Instrument	22-12
Plester Micro Ear Knife	22-9
Politzer Ear Speculum	22-18
Politzer Paracentesis Needle	22-36—22-37
Probes-Rhinology	23-49
<b>Q</b>	
Quire Foreign Body Lever	22-29
Quire Nasal Polypus Forcep	23-9
<b>R</b>	
Ramus Retractors	24-15
Raspatories	22-38
Reichert Epiglottis Retractor	25-18
Rhinoplastic and Nasal Knives	23-20, 23-22
Rhinoplastic Instruments	23-16, 23-36, 23-30, 23-32—23-34, 23-37—23-44
Richnau Holmgren Ear Speculum	22-20
Ritter-Halle Probe	23-49
Roder Ligature Carrier	25-3
Roger Septum and Periosteal Elevator	23-25
Rosen Curette	22-12
Rosen Ear Needle	22-10—22-11
Rosen Elevator	22-12
Rosen Micro Ear Knife	22-9
Rosen Mobilizer	22-12
Rosenberg Grasping Forcep Tip	25-13
Rosen-Konig Mouth Gag	24-2
Rowe Disimpaction Forcep	24-20
Rubin Osteotome	23-29
Rubin Septum Forcep	23-15
Rubin-TC Septum Forcep	23-15
Rydel-Seiffert Tuning Fork	22-26
<b>S</b>	
Scheinmann Grasping Forcep Tip	25-13
Schmeden Nasal Cutting Forcep	23-13
Schuknecht Ear Needle	22-16
Schuknecht Micro Ear Knife	22-9
Schuknecht Wire Closure Forcep	22-6
Schumacher Cutting Forcep Tip	25-13
Seemann-Seiffert Mouth Gag	24-6
Seiffert Grasping Forcep Tip	25-13

## Index

Septum and Periosteal Elevator	23-24—23-25
Septum Chisels	23-26—23-27
Septum Compression Forcep	23-9—23-10, 23-14
Septum Elevators	23-23
Septum Forceps	23-15, 23-44
Septum Gouges	23-26—23-27
Septum Knives	23-21
Septum Scissors	23-15
Sexton Paracentesis Needle	22-36
Shambaugh-Derlacki Elevator	22-39
Shapleigh Ear Curette	22-32
Shea Foot Plate Instrument	22-13
Sheehan Osteotome	23-29
Siebenmann Wash Catheter	23-49
Silver Osteotome	23-30
Simplex Cheek-Lip Retractor	24-8
Sinuscopy Forceps	23-50—23-56
Skin Grasping Forceps	23-43
Sluder-Ballenger Tonsillectome	25-9
Snellen Ear Loop	22-35
Soft Tissue Retractors	24-14
Sphenoid Punches	23-17—23-19
Spoons-Ear	22-33
Sprague Paracentesis Needle	22-37
Sprague Paracentesis Knife	22-37
St.Clair-Thompson Adenoid Curette	23-47
Stammerger Sinuscopy Forcep	23-56
Standard Sinuscopy Forcep	23-54
Standard Tongue Depressor	24-10
Stanzen Punch Sinuscopy Forcep	23-53
Stenberg Cheek-Lip Retractor	24-8
Struempel Ear Polypus Forcep	22-30
Struycken Nasal Cutting Forcep	23-12
Struycken Septum Compression Forcep	23-14
Struycken Sinuscopy Forcep	23-52
Suction Tubes-Ear	22-17
<b>T</b>	
Tabb Micro Ear Knife	22-9
Takahashi Nasal Cutting Forcep	23-11
Takahashi Sinuscopy Forcep	23-52
Thudicum Nasal Speculum	23-2
Tieck-Halle Nasal Speculum	23-3
Tobold Tongue Depressor	24-9
Tongue Depressors	24-8—24-11
Tongue Holding Forcep	24-13
Tonsil Forceps	25-5
Tonsil Hemostats	25-10
Tonsil Knives	25-3—25-4
Tonsil Needles	25-2
Tonsil Packers	25-5
Tonsil Punch Forceps	25-10
Tonsil Retractors	25-5—25-6
Tonsil Seizing Forceps	25-7
Tonsil Snares	25-8
Tonsillectomes	25-9
Toynbee Ear Speculum	22-18
Troeltsch (Wilde) Ear Dressing Forcep	22-28
Troeltsch Nasal Dressing Forcep	23-8
Tuding Tonsil Snare	25-8
Tuning Forks	22-21—22-26

<b>U</b>	
Univ.Minnesota Tongue Depressor	24-10
Universal Handles and Interchangeable Tubes	25-12
<b>V</b>	
Vetter-Ulrich Tonsil Hemostats	25-10
Votolini Nasal Speculum	23-2
<b>W</b>	
Wagener Ear Hook	22-35
Walsham Septum Forcep	23-44
Walter Chisel	23-29
Walter Osteotome	23-29
Wash Cannulas-Rhinology	23-49
Wash Catheters-Rhinology	23-49
Watson-Williams Nasal Cutting Forcep	23-11
Weil Nasal Cutting Forcep	23-11
Weil-Blakesley Nasal Cutting Forcep	23-12
Weil-Blakesley Sinuscopy Forcep	23-50—23-52
West Septum Chisel	23-27
West Septum Gouge	23-27
Westmacott Nasal Polypus Forcep	23-8
White Tonsil Seizing Forcep	25-7
Whitehead Mouth gag	24-6
Wieder Tongue Depressor	24-9
Wiener Nasal Rasp	23-34
Wire Closure Forceps	22-6
Wullstein Elevator	22-39
Wullstein Micro Ear Forcep	22-8
Wullstein Micro Ear Knife	22-9
Wullstein Micro Ear Scissor	22-5
Wullstein Suction Tube	22-17
<b>Y</b>	
Young Tongue Holding Forcep	24-13
<b>Z</b>	
Zaufal Foreign Body Instrument	22-34
Zollner Ear Hooklet	22-15
Zollner Ear Needle	22-15
Zollner Ear Speculum	22-19
Zollner Suction Tube	22-17



Address.  
1233 W Capitol Dr, Suite D  
Addison, IL 60101 USA,

Phone.  
+1 773-997-3421

Email.  
[info@tritoneinc.net](mailto:info@tritoneinc.net)

[www.tritoneinc.net](http://www.tritoneinc.net)